



Focus point cloud software

Streamlining CMM and handheld laser scanning inspection



| | |
|-------|--------------|
| Nr. 4 | Dev. |
| Y: | 0.875 |
| 3D: | -0.875 No Go |

| | |
|-------|----------|
| Nr. 1 | Dev. |
| Y: | -0.026 |
| 3D: | 0.026 Go |

| | |
|-------|-------------|
| Nr. 6 | Dev. |
| Y: | -0.891 |
| 3D: | 0.892 No Go |

Nikon th
100
anniversary

NIKON METROLOGY | VISION BEYOND PRECISION

BETTER INSIGHTS, EARLIER

Focus point cloud software drives a digital inspection process. The core of this process is the 3D inspection suite featuring easy-to-interpret part-to-CAD comparisons and advanced feature inspection. Focus also manages the data acquisition from laser scanner on CMMs and articulated arms, including off-line preparation to automate CMM scanning tasks.

Focus benefits

Focus Inspection software covers a wide range of inspection applications and offers stunning performance, an intuitive user interface, and standard macro functionality to automate the entire inspection process.

- Seamlessly integrated scanning and inspection for CMM and handheld laser scanning inspection workflows for both operators and engineers
- New ribbon toolbar facilitates inspection workflows
- Intelligent feature detection and analysis algorithms resulting in high productivity and consistent results
- Most complete set of functions for digital surface and feature inspection
- Easy-to-interpret and interactive reporting to facilitate decision making
- Inspection automation without requiring programming skills
- Share 3D results with colleagues and customers with free Focus Viewer

Part-to-CAD inspection workflow

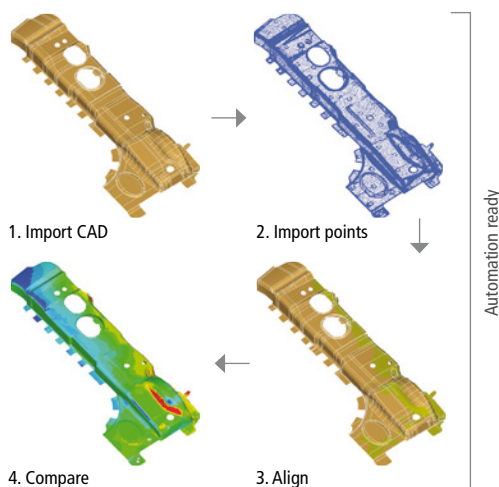

Imports common CAD formats

- CATIA V4/V5, Pro-E, IGS, STP, VDA, SAT®, Unigraphics®
- Imports GD&T information & features of nominal CAD

Superior point cloud handling

- Analyzes virtually unlimited point clouds (> 100 million points)
- Most complete set of point cloud tools (filtering, meshing, quick shading, etc.)
- Fuse command intelligently and automatically processes the scanned pointcloud data into an accurate, high quality polygon mesh

Alignment tools

- 3D and 2D (section) best fit
- (feature-based) RPS
- 3-2-1 alignment

Complete part-to-CAD inspection toolbox

- Comparison of parts against CAD or other scanned parts
- 3D deviation color maps make interpretation straightforward

CMM SCANNING

Focus Scan serves off-line and online scanner path definition. Focus' Off-line Scan module enables the user to create, modify and prove out part programs based on 3D CAD models while allocating CMMs exclusively for measurement. Focus Scan drives online CMM scanner motion, acquires the data, and pre-processes the raw point cloud.

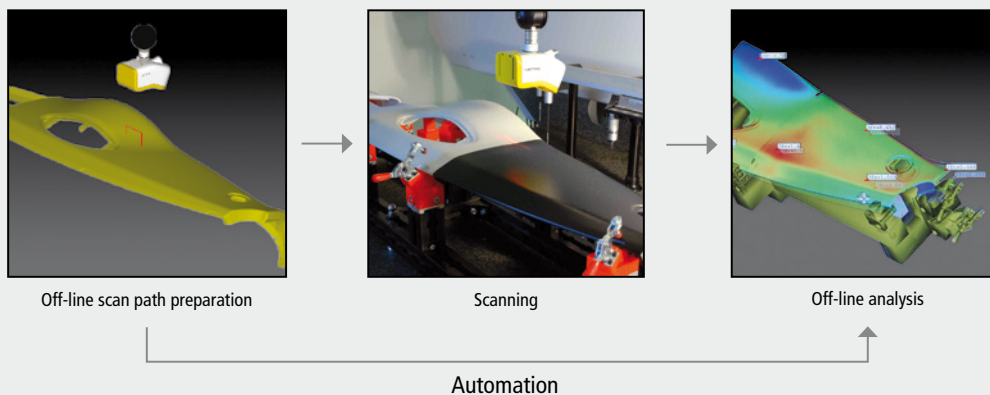

Focus Scan Off-line

- Automatic generation of scan path and angles specification
- Virtual scan generates simulated data
- Supports off-line inspection programs
- Focus Scan also supports online inspection programs
- Reused on the CMM
- Focus Scan is compatible with various CMMs

ALL FUNCTIONALITIES AT YOUR FINGERTIPS...

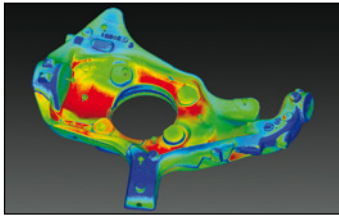

A picture tells more than a thousand words, while sections give detailed information on the deviations.

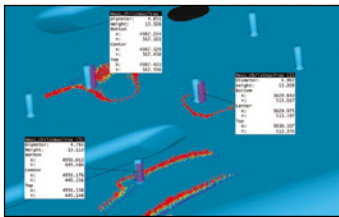
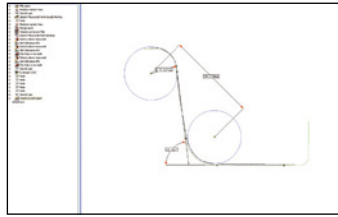

Based upon nominal feature information loaded from the CAD model, Focus Inspection automatically extracts the corresponding feature from the acquired point cloud and compares the two.

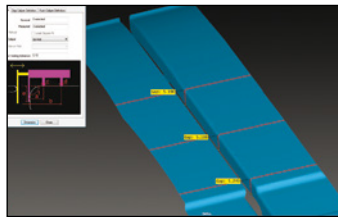

Correct flush & gap improves aerodynamic performance and the visual perception of quality.



2D hole and slot features



Bolt



Fir tree



Flush & gap measurement

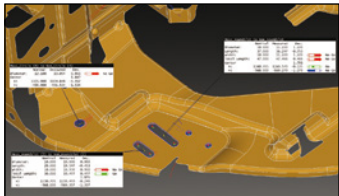

Clear user-tailored flyouts instantly reveal all GD&T information.

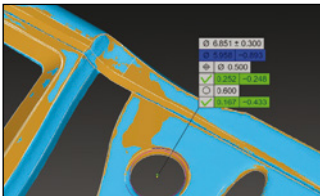

Surface inspection

Part-to-CAD inspection compares the acquired point cloud with nominal CAD data, and displays geometric deviations in a clear graphic report. Surface inspection is used to study material springback and shrinkage phenomena and to make sure that the shape of the part is as designed.

- Full part-to-CAD inspection
- 2D and 3D sections
- Wall thickness, edge analysis, etc.
- Customizable flyouts for clear interpretation

Feature inspection

Checking the position and dimensions of component features is crucial in order to guarantee an optimal fit later in the assembly process.

- Automatic and semi-automatic feature detection
 - 2D features: surface point, hole, slot, plane, etc.
 - 3D basic features: cylinder, sphere, etc.
 - 3D advanced features: T-Stud, diamond pin, fir tree, etc.
- Sectional inspection of flush & gap between assemblies (body, door, trunk, etc.)
 - Definition of user-specific flush & gap gauges
 - Combi hem: creation of virtual edge points

A true metrology solution

A perfect assembly is guaranteed when the feature geometries meet the specified tolerances. Focus Inspection supports the internationally accepted ASME Y14.5 GD&T standard, making it a true metrology solution.

- Imports GD&T data from nominal CAD
- Complete set of certified GD&T functions to define tolerances on form, orientation and location
- PTB certified feature calculation algorithms



benefits

path from CAD, including optimum probe head

d point cloud

programming with virtual point clouds

programming and allows off-line programs to be

a wide range of CMMs

PORTABLE, HANDHELD INSPECT



Focus streamlines handheld acquisition and processing

...SERVING SMOOTH INSPECTION

Virtual assembly

Digital copies of reference parts are used to build an assembly with the CAD model or other point cloud data. This approach saves material by avoiding expensive templates, fixtures and scrap. It saves additional time by avoiding lengthy physical assembly builds, resulting in faster decision-making and shorter pre-production processes.

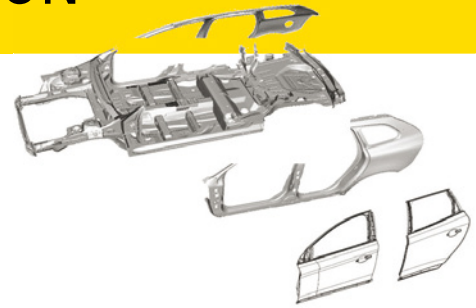

Combining CAD and measured data enables the detection of possible mating conflicts in a very early stage of the process.

Automation

Focus Inspection incorporates standard automation functionality that supports non-stop execution of repetitive inspection tasks. This allows multiple scan files or even the complete inspection cycle of a series of specimens to be processed automatically.

- Automation of CMM-based scan process and inspection analysis
- Macro-based recording of actions:
 - No specific programming skills required
 - No editing of text files needed

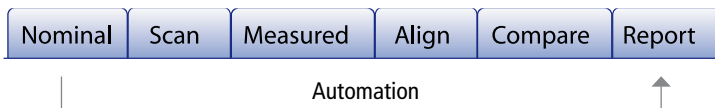

Macros automate the entire inspection workflow, from nominal CAD import to final reporting.

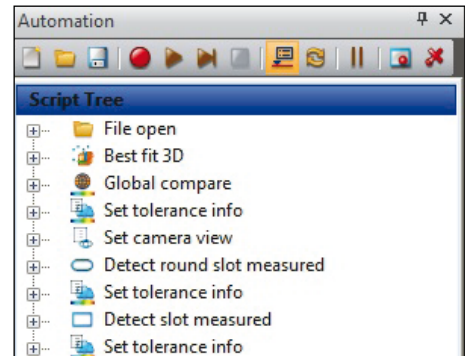

Automation records all actions executed by the user. The resulting analysis script can be replayed on other parts with one click.

Reporting

Correct decision making is based on the fast and unambiguous interpretation of measurement results. Because 3D graphical deviation reports provide results in an easy understandable format, Focus Inspection facilitates communication between operators, managers and suppliers.

- Customizable Microsoft Excel template based reporting
- Statistical Process Control (SPC): Q-Stat, QC-Calc, DMIS, txt
- Data export to a variety of file formats to flexibly share results with other users and applications
- Free Focus Viewer software to create user-specific 3D analysis reports

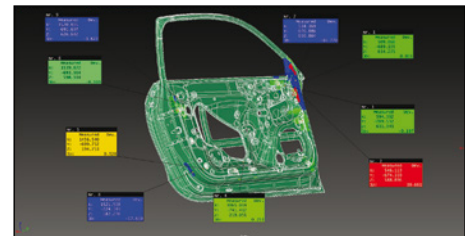

CTION

Portable CMMs are flexible scanning solutions that are typically used in on-site or one-off inspection jobs, such as pre-series troubleshooting. The preparation effort is limited to system setup, followed by scanning the part and performing the analysis.

- Dedicated scanning solutions for all handheld scanning tasks
 - Optical CMM for full-freedom measurement in large, expandable working volumes
 - 7-axis articulated arm with high-productivity scanners
- Inspection macros created for scan data acquired on a CMM, can seamlessly be reused for geometry data captured using a handheld scanner
- Comparison of data against CAD or point clouds from other parts

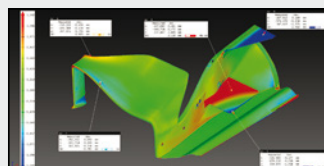
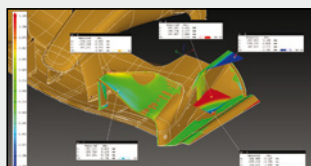
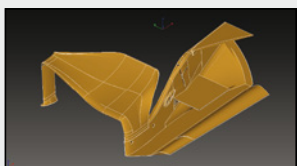

INTRODUCING FOCUS

Focus presents a clear, graphical UI where users will feel at ease immediately with direct access to most used functions. Focus offers tightly integrated data acquisition – via CMM or handheld scanners – and intelligent processing and reporting. Direct access to workflow selection, customization and automation facilitate the setup and execution of processing jobs. Focus drives seamlessly latest-generation Nikon Metrology CMM and handheld laser scanners, and supports many CMM and articulated arm brands

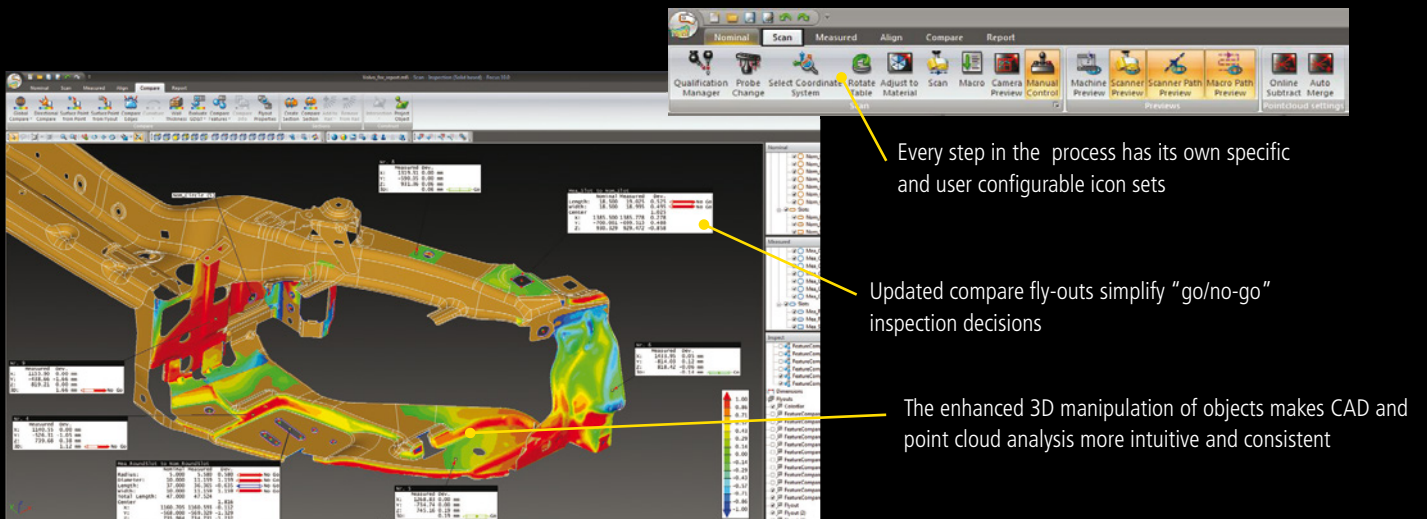

THE DIGITAL INSPECTION PROCESS

Nikon Metrology solutions essentially feed critical geometric measurement data into today's digital information streams that drive new product development and fabrication. Smart digital inspection solutions, such as Focus software and laser scanners, accurately and automatically digitize the complete geometry of freeform surfaces and features.

Digitizing components up-front and running inspection on the digital copies of the samples, streamlines metrology operations and embeds them into the digital CAD-centric development process. As a Digital Inspection Process provides more profound metrology insight, it is essential to improving and accelerating styling, tooling, prototyping and serial production.

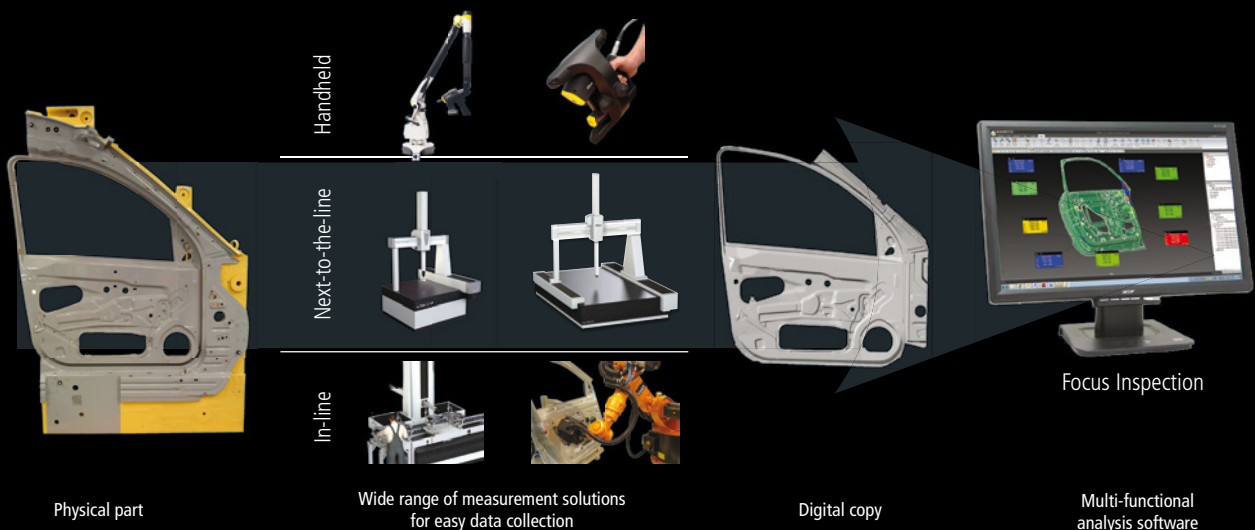

A WEALTH OF APPLICATIONS

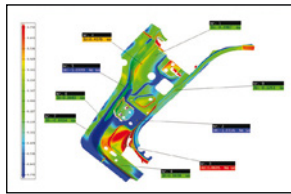

Sheet metal inspection

Sheet metal and body panel inspection, mainly used in the automotive industry, is one of the target applications for Focus Inspection. Not only 3D forms need to be inspected, but also features, edges, and assemblies. Techniques including surface inspection and virtual matching, GD&T, and flush & gap analysis, complete a comprehensive toolbox for running your inspection job. Automation capabilities allow the process to be smoothly streamlined into standard processes, in-line or off-line.

Plastic molding inspection

Plastic injection molding is characterized by various material-dependent process behaviors: shrinkage due to cooling down, material flows, humidity absorption, etc. Therefore, a visual 3D inspection report is an indispensable tool to quickly detect any part imperfections. Whereas a scanner is ideal to inspect the outer surface, CT scanning is the ultimate solution when detailed insight into the inner structure is required.

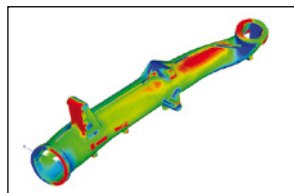
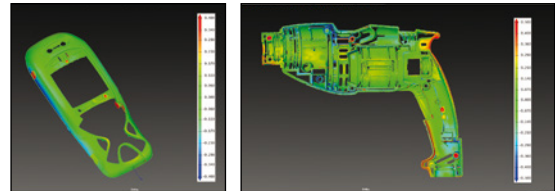

Casting inspection

The complete casting process is characterized by a strict inspection of the surface shape. Molds and sand cores as well as pre-series samples require detailed inspection to guarantee correct serial production. Serial production also needs sample-based preventive monitoring to detect wear early on in the process. CMM laser scanning and/or CT offer quick and complete 3D digital copies for

in-depth inspection. In case specific features need detail inspection, CMM laser scanners can be seamlessly integrated with touch probe point and scanning measurements.

Turbine blade inspection

Turbine Blade Inspection is a dedicated module in the Focus Inspection portfolio. The efficiency of turbine blades is defined by their profile, hole features, correct placement in the turbine, and uniformity of turbine blade wear. The Focus Turbine Blade Inspection module offers a wealth of functionalities for automatic inspection of series of blades.

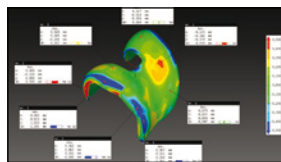
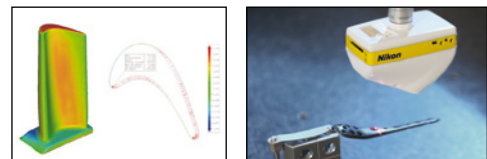

Medical implants

With medical devices, failure is not an option. For medical components, such as knee or hip implants and hearing aids, the as-built shape of the component is crucial for fast patient recovery and maximum comfort. By digitizing a patient-specific part, the entire geometry can be evaluated on the basis of graphic color diagrams



NIKON METROLOGY NV

Geldenaaksebaan 329
B-3001 Leuven, Belgium
phone: +32 16 74 01 00 fax: +32 16 74 01 03
Sales.NM@nikon.com

NIKON METROLOGY EUROPE NV
tel. +32 16 74 01 01
Sales.Europe.NM@nikon.com

NIKON METROLOGY GMBH
tel. +49 6023 91733-0
Sales.Germany.NM@nikon.com

NIKON METROLOGY SARL
tel. +33 1 60 86 09 76
Sales.France.NM@nikon.com

NIKON METROLOGY, INC.
tel. +1 810 2204360
Sales.US.NM@nikon.com

NIKON METROLOGY UK LTD.
tel. +44 1332 811349
Sales.UK.NM@nikon.com

NIKON CORPORATION

Shinagawa Intercity Tower C, 2-15-3, Konan,
Minato-ku, Tokyo 108-6290 Japan
Telefon: +81-3-6433-3701 Fax: +81-3-6433-3784
www.nikon.com/products/industrial-metrology/

NIKON INSTRUMENTS (SHANGHAI) CO. LTD.
Tel.: +86 21 5836 0050
Tel.: +86 10 5869 2255 (Beijing office)
Tel.: +86 20 3882 0550 (Guangzhou office)

NIKON SINGAPORE PTE. LTD.
Tel.: +65 6559 3618
nsg.industrial-sales@nikon.com

NIKON MALAYSIA SDN. BHD.
Tel.: +60 3 7809 3609

NIKON INSTRUMENTS KOREA CO. LTD.
Tel.: +82 2 2186 8400

ISO 14001 Certified
for NIKON CORPORATION

ISO 9001 Certified
for NIKON CORPORATION
Microscope Solutions Business Unit
Industrial Metrology Business Unit

More offices and resellers at www.nikonmetrology.com