

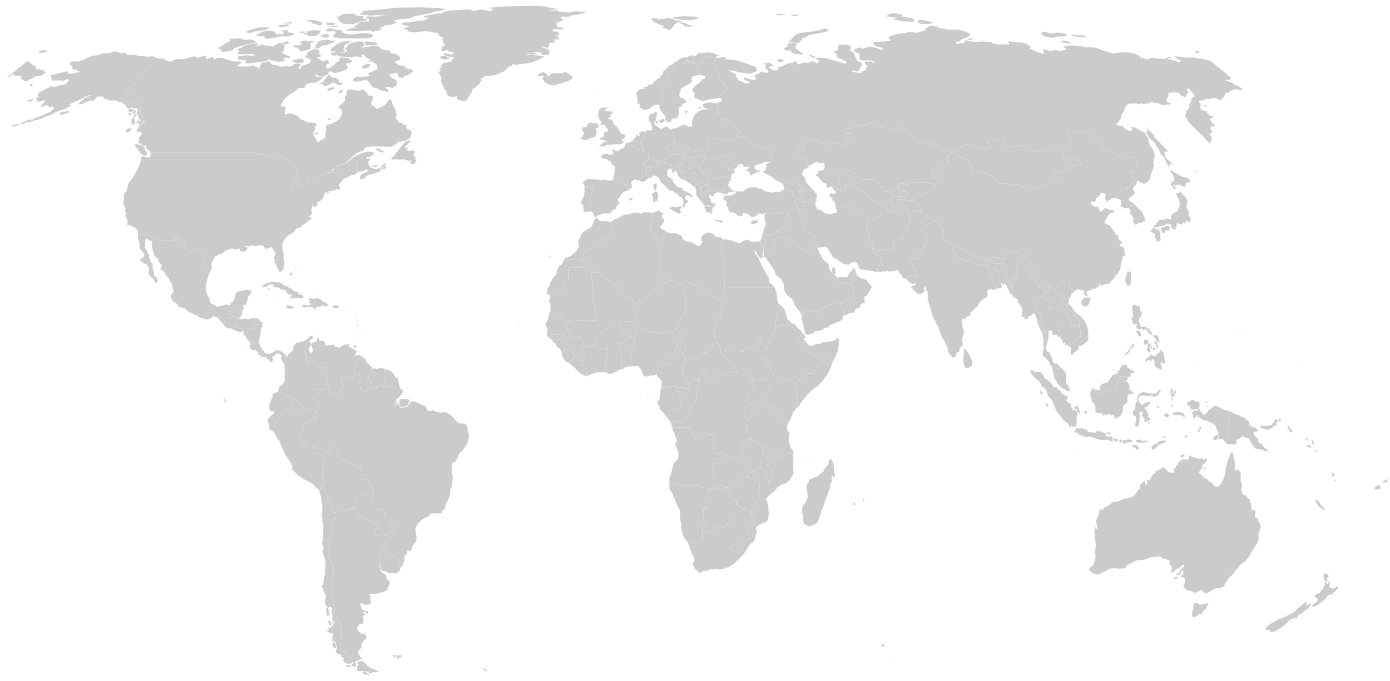

INDUSTRIAL METROLOGY



# Nikon Metrology Solutions

X-RAY AND CT INSPECTION

LARGE VOLUME METROLOGY

VIDEO MEASURING SYSTEMS

MANUAL MEASURING INSTRUMENTS

MATERIALS AND INDUSTRIAL MICROSCOPY SOLUTIONS

MULTI-SENSOR METROLOGY

SERVICE AND SUPPORT

## 4 X-ray and CT inspection

X-RAY SOURCES  
XT H SERIES INDUSTRIAL COMPUTED TOMOGRAPHY SYSTEMS  
MCT225 METROLOGY CT  
LARGE ENVELOPE SYSTEMS  
CT AUTOMATION  
XT V SERIES ELECTRONICS X-RAY INSPECTION

## 14 Large Volume Metrology

LASER RADAR  
SHOP FLOOR CMM

## 19 Video Measuring Systems

iNEXIV VMA VIDEO MEASURING SYSTEM SERIES  
NEXIV VMZ-S VIDEO MEASURING SYSTEM SERIES  
CONFOCAL NEXIV VMZ-K VIDEO MEASURING SYSTEM SERIES

## 23 Manual Measuring Instruments

MANUAL MEASURING MICROSCOPES  
PROFILE PROJECTORS  
DIGIMICRO DIGITAL HEIGHT MEASURING SYSTEMS  
AUTOCOLLIMATORS

## 26 Materials and Industrial Microscopy Solutions

STEREOSCOPIC MICROSCOPES  
MATERIALS AND INDUSTRIAL COMPOUND MICROSCOPES  
BW SERIES – WHITE LIGHT INTERFEROMETRIC MICROSCOPE SYSTEM  
NEOSCOPE BENCHTOP SCANNING ELECTRON MICROSCOPE  
SOFTWARE SOLUTION OVERVIEW

## 33 Multi-sensor Metrology

CMM SCANNERS FOR AUTOMATED METROLOGY  
MODELMAKER SCANNERS FOR HANDHELD METROLOGY  
MCAx S PORTABLE CMM ARMS  
3D SCANNING METROLOGY SOFTWARE

## 38 Services and Support



Get the inside picture of complex electronics or industrial parts, by looking into the internal structure. Then use CT capability to qualify and quantify any inner or outer dimension, all in a smooth, non-destructive process.

# X-ray and CT inspection

X-RAY SOURCES

XT H 225 INDUSTRIAL CT

XT H 225 ST 2x INDUSTRIAL CT

MCT225 METROLOGY CT

XT H 320 INDUSTRIAL CT

XT H 450 HIGH VOLTAGE CT

LARGE ENVELOPE SYSTEMS

CT AUTOMATION

XT V 130C / XT V 160 ELECTRONICS X-RAY INSPECTION

# In-house design and build

Nikon Metrology X-ray sources are at the heart of our technology and have been designed and manufactured in-house from 1987 to this day; offering over 30 years of knowledge. Being at the heart of the image, control over the X-ray source technology allows Nikon Metrology to quickly move with the market and develop complete and innovative solutions to the application demand. All sources are open-tube giving a low cost of ownership and range from low (180) to medium (225) to high (450) kV, all with micron resolution.

One X-ray tube, five target modules, limitless applications

### 180 kV TRANSMISSION TARGET

- Liquid-cooled Transmission Target
- Sub-micron feature recognition
- High resolution up to 180 kV
- Perfect for high resolution CT of small samples



### 225 kV REFLECTION TARGET

- Liquid-cooled Reflection Target
- Spot size down to 3 micron
- High resolution up to 225 kV
- Outstanding image quality and high resolution across a broad sample range



### 225 kV ROTATING TARGET 2.0

- Liquid-cooled Rotating Reflection Target
- 3x higher resolution for the same power as static target
- 3x higher power for the same resolution as static target
- Resulting in significantly faster scan times
- No cool-down periods; continuous operation up to a stunning 450 Watts power



### 320 kV SOURCE

- Liquid-cooled Reflection Target
- Unique 320 kV high-power microfocus source
- Penetrates dense samples while maintaining high resolution
- Ideal for rock cores, castings and dense objects



### MULTI-METAL TARGET

- Industry unique multi-metal target
- Optimise the X-ray profile generated
- Change metals without breaking vacuum
- Unrivalled flexibility for complex applications
- Versatility to enhance image contrast, perfect for materials research and more



The World's only 450 kV microfocus source



### 450 kV REFLECTION TARGET

- Unique 450 kV microfocus source with 25 micron accuracy and repeatability
- Rotating Target source option for 5x faster scanning
- Liquid-cooled advanced technology for 450 Watt continuous power
- Orders of magnitude higher resolution than minifocus sources at same energy
- Industry leading performance with faster scan times and higher accuracy



# Enter the world of X-ray CT

Detailed capture and measurement of internal component and assembly features is vital for quality control, failure analysis and material research.

The entry-level XT H 225 systems feature a microfocus X-ray source offering high image resolution, and large inspection volume for a small system footprint.

Ready for ultrafast CT reconstruction, the XT H 225 covers a wide range of applications, including the inspection of plastic parts, small castings and complex mechanisms as well as researching materials and natural specimens.

### FEATURES

- Choice of different proprietary microfocus X-ray sources
  - 180 kV Transmission target
  - 225 kV Reflection target
- Wide range of high-quality flat panel detectors
- Real-time X-ray visualization, fast CT reconstruction
- 5-axis fully programmable part manipulator
- Customizable macros automate measurement workflow
- Excellent inspection volume for small footprint

### BENEFITS

- Incredible versatility and optimisation for a vast range of applications and samples
- Flexible systems allow both quick visual inspection and in-depth analysis
- The lowest maintenance costs thanks to in-house design and build
- Fast and reliable high-quality data for all user requirements
- Shorter training times and easy workflows deliver a fantastic user experience
- Ultra-fast scan times and maximised image quality
- Easily optimise quality and resolution for different samples

### COMPUTED TOMOGRAPHY

To generate a 3D CT volume, a series of sequential 2D X-ray images are captured as the object is rotated through 360°. These images are then reconstructed to generate a 3D volumetric representation of the object. In addition to the outer surfaces, the reconstructed volume contains all information of interior surfaces and structure - as well as information on the material structure. It is possible to navigate through the CT volume at any given point, through any plane. As a result even interior measurements can be easily obtained, as well as the added benefit of localizing structural material imperfections and identifying assembly errors not usually visible through traditional methods of NDT.

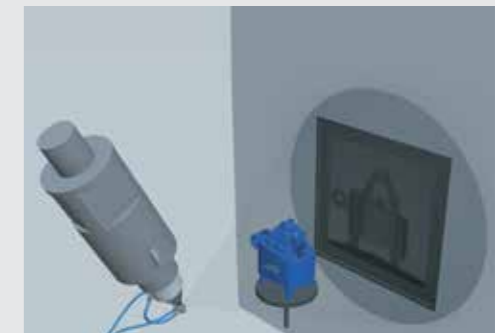

X-RAY SOURCES

XT H 225



## Productivity without compromise

The XT H 225 ST 2x system is ideally suited to a wide range of materials and sample sizes. The system can be configured with a range of industry-leading flat panel detectors, up to 2,880 x 2,880, 150 µm pixels, to best suit the user application.

Tools for increasing scan speed, prolonging system uptime and maintaining measurement accuracy, when combined with the interchangeable X-ray targets and motorized FID, provide a flexible tool for Quality Control laboratories, Production facilities, Research and Development departments and academia.

### AVAILABILITY AND PRODUCTIVITY

**Auto.Filament Control** intelligently controls the X-ray source to double the lifetime of the filament, without long-life filaments that would reduce the high resolution micro-focus nature of the source. Less frequent changing of the filament means the system is available more of the time.

When a short turnaround is required, **Half.Turn CT** allows faster CT scans by only rotating the sample just over 180 degrees. Novel centre of rotation and new reconstruction algorithms allow automated scans which retain the quality of a longer 360 degree CT scan.

### TRACEABLE ACCURACY

Automated calibration of any CT scan position is possible with **Local.Calibration**; leading to improved measurement accuracy for metrology applications.

As the CT scan position is calibrated with reference to a known artefact, measurements can be made with a high level of confidence with traceable procedures.

### UNRIVALLED FLEXIBILITY

With four X-ray target heads, unique flexibility is achieved from a single source. Targets are easily user exchanged, to allow optimisation of the source for the sample being scanned.

With a motorised FID (Focal spot to Imager Distance) adjustment, the user does not have to increase either X-ray power or detector exposure to compensate for the fall in X-ray intensity between the source and flat panel detector. A faster scan time or a higher signal to noise ratio is possible when a shorter FID is selected.

### AUTOMATED DETECTOR EVALUATION

The condition of the digital X-ray detector has a considerable influence on the efficiency and accuracy with which features are revealed and measured, so being able to evaluate and track its performance over time is crucial.

Flat panel detectors at Nikon Metrology are qualified to ASTM E2597 and users are able to evaluate and track the performance of the detector in accordance with ASTM E2737. Dedicated software performs all necessary functions, including artefact manipulation, image collection and data analysis, creating a detailed report automatically and rapidly with unique performance tracking and trend analysis.

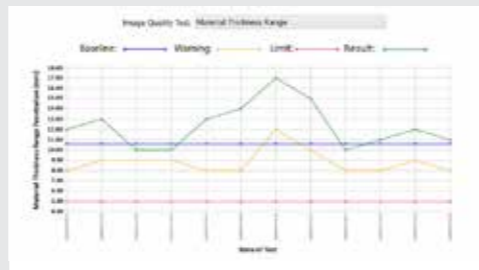

## Absolute accuracy for inside metrology

MCT225 efficiently measures internal and external geometry without reference measurements and damaging the sample. With over 30 years' X-ray experience, Nikon Metrology's pedigree for reliable high quality Metrology CT is second to none.

### FEATURES

- Nikon Metrology developed micro-focus X-ray source
- Temperature controlled enclosure
- High precision linear guideways
- Axis travels error corrected
- Liquid cooled X-ray source
- High resolution optical encoders
- High resolution 4 Megapixel detector
- Finite Element Analysis (FEA) optimized manipulator

### ABSOLUTE ACCURACY

MCT225 is pre-calibrated using accuracy standards traceable to the UK's national measurement institute (NPL) and verified using VDI/VDE 2630 guidelines for Computed Tomography in Dimensional Measurement. Absolute Accuracy guarantees measurement accuracy without time consuming comparative scans or reference measurements, samples are simply placed on a rotary table inside the enclosure and measured. Several key metrology features provide long term stability and enable the MCT225 to achieve an impressive MPE of 9+L/50 µm.

### METROLOGY CT PROCESS

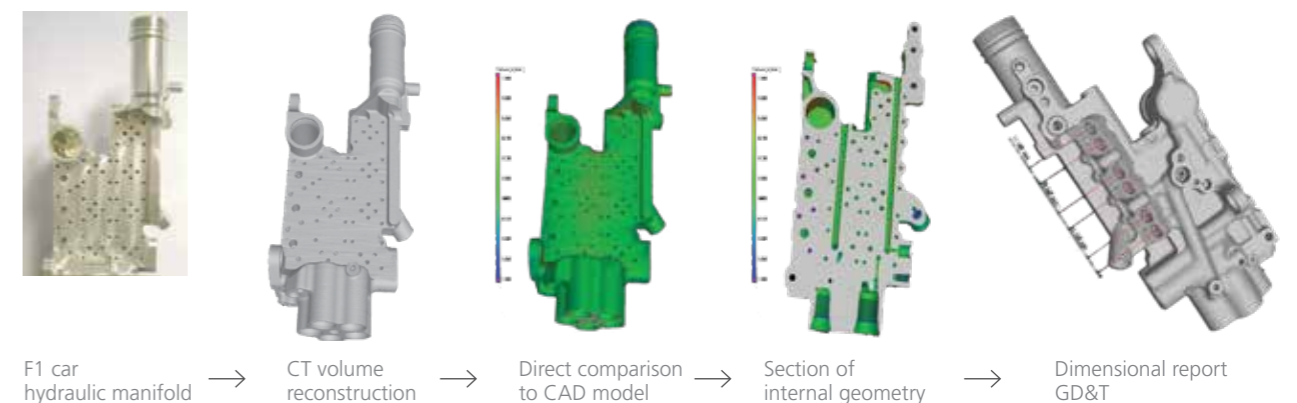

XT H 225 ST 2x

MCT225 METROLOGY CT



## Large cabinet microfocus CT

The XT H 320 is a large cabinet system for the X-ray CT scanning and metrology of large components. The system consists of a 320 kV microfocus source delivering up to 320 W of power.

A high resolution flat panel is used to collect high quality images of the sample. The system is controlled by Inspect-X software which makes the collection of CT data and setting up of measurements simple and easy. The system can output volume data to industry leading visualization and analysis software.

### STUNNING IMAGES

Multi-material or lower attenuating samples are better scanned with high-quality flat panel detectors due to the high dynamic range. High resolution voxel data is achieved in CT scans by having flat panel detectors with many pixels. The larger cabinets are configurable with a wide range of high-quality detectors, including higher-resolution to 4,000 x 4,000 pixels, for razor sharp images.

### 320 kV MICROFOCUS

Most system suppliers only offer microfocus sources up to 225 kV, while more powerful sources in their offerings are minifocus. With larger samples, one often needs more penetration power and therefore Nikon Metrology offers a unique 320 kV microfocus X-ray source. As the X-ray spot size of these sources is orders of magnitude smaller compared to minifocus sources, end users benefit from superior resolution, accuracy and a wider array of measurable parts.

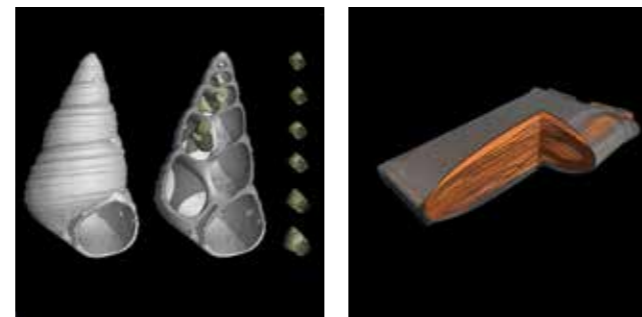

Snail fossil

Battery

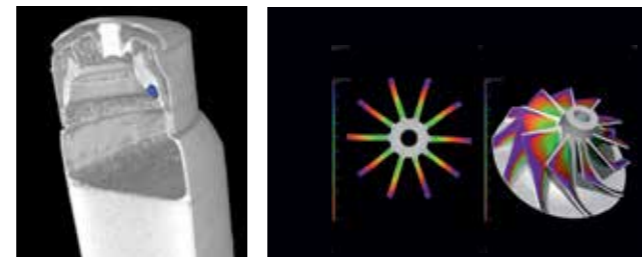

Shaving foam can

Wall thickness evaluation on impeller



## High voltage 450 kV microfocus CT

The XT H 450 sets a new reference for turbine blade measurement and NDT inspection of small to medium castings. At the core of this powerful equipment is a 450 kV microfocus source, providing superior resolution and accuracy.

The curved linear array detector optimizes the collection of X-rays by eliminating scatter phenomena that typically corrupt 2D radiographs of blades and other metal parts.

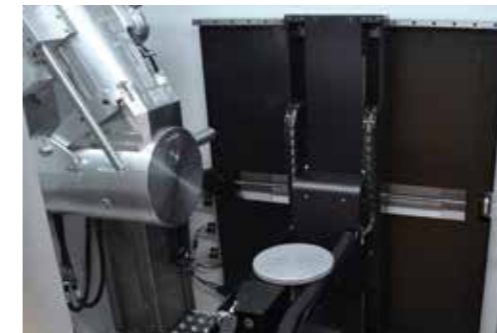

The 450 kV high-brilliance source provides the same advantages as a rotating target: faster data collection or a higher data quality at continuous power

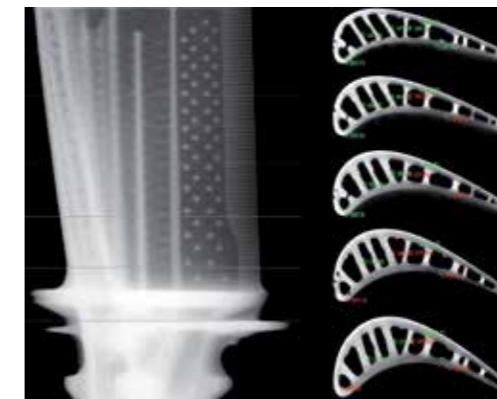

X-ray image and CT slices of a single-crystal aerospace turbine blade generated using a Curved linear diode array (CLDA) detector.

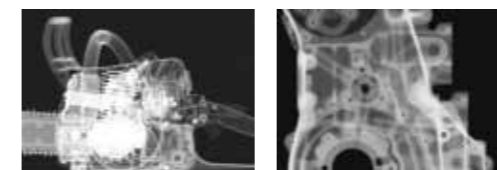

X-ray of chainsaw

X-ray of engine casting

### FEATURES

- Unique open-tube 450 kV microfocus source
- Unique Rotating Target option available
- Different imaging options
  - Varex flat panel detector (XT H 450 3D)
  - Curved Linear array Detector (XT H 450 2D)
  - Combination of flat panel and CLDA detector
- Measuring volume up to 600 mm diameter and 600 mm height
- 5-axis fully programmable turntable manipulator with precision ball screws and linear slides
- Dedicated application for automatic pass/fail inspection of turbine blades

### FASTER THROUGHPUT OR HIGHER DATA QUALITY WITH ROTATING TARGET

The 450 kV Rotating Target enables the user to get the most out of this XT H 450 system. For a given spot size and power, data can be collected typically 3-5x faster, giving the user faster throughput. Alternatively for a given power and measurement time, the available resolution will be higher and so the data quality will be improved. The Rotating Target also delivers continuous 450W without measurement time restriction.

### APPLICATIONS

- Detailed analysis of the wall thickness and internal structure of turbine blades
- Automated pass/fail inspection of blades
- Inspection of high density parts (e.g metal parts, castings) with a need for micron accuracy

XT H 320

XT H 450

# Limitless configurations for precision CT scanning

Nikon Metrology's configurable X-ray/CT systems offer a large inspection envelope, supports multiple sources, multiple detectors and can be custom-configured to fit a variety of applications. Nikon Metrology's modular microfocus CT systems can be built into existing cabinets or walk-in rooms to upgrade older film-based facilities or mini-focus systems.

The core of these configurable systems are the Nikon in-house-built microfocus sources up to 450 kV. The focal spot size of these microfocus sources is orders-of-magnitude smaller when compared to mini-focus sources, which results in superior resolution and accuracy.



## LARGE ENVELOPE PRECISION CT SCANNING SYSTEM

Dense and unwieldy objects are perfect for the C2 scanning system. Configurable with dual sources, dual detectors and multi-position panel shifting, this system can accurately scan objects up to 150 kg in weight. The C2 delivers an unrivalled inspection envelope via synchronized vertical X-ray source and detector motion. The system offers perfect precision thanks to its 4.3-meter long granite foundation and is configurable with a flat panel detector and Nikon Metrology's Curved Linear Diode Array (CLDA) to reduce scatter and dramatically improve image definition.

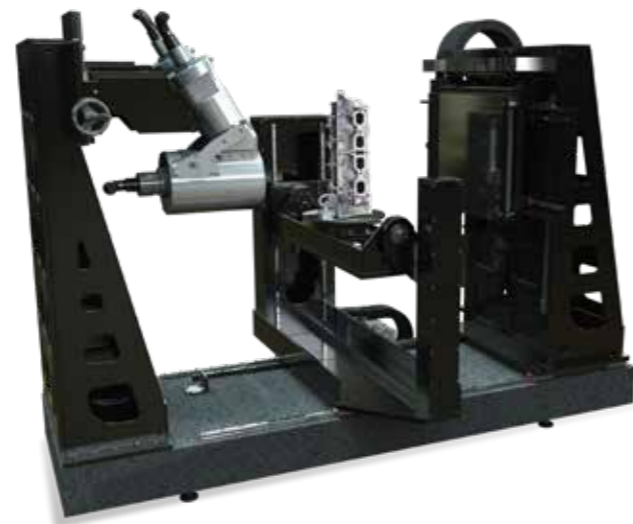

## COMPACT PRECISION CT

The M2 completely redefines industrial CT scanning. Configurable for dual sources, dual detectors and multi-position panel shifting, this system can accurately scan objects of all shapes and sizes. The M2 is equipped with a vertical manipulator as well as a tilting turntable, with a sample bridge supported on both ends for ideal positioning and accuracy.

# Nikon CT Automation ready for production

An important challenge to manufacturers is to increase product quality, which can be achieved through 100% part inspection. Recent advances in high-resolution high-flux rotating targets for X-ray sources, coupled with easy automation of CT scanning parameters and analysis techniques allow samples to be scanned, reconstructed and evaluated in under two minutes. This opens the gate to a broad span of automation inspection applications, varying from simple pass/fail inspection to full in-line automated CT inspection with feedback to the production process.

## Batch CT Inspection

As standard, Inspect-X allows to save profiles with scan and reconstruction parameters ensuring repeatability of the complete CT process.

### BENEFITS

- No programming skills required
- Inspect-X loads appropriate analysis and reporting programs
- User is free to do parallel tasks such as sample preparation



Batch inspection allows automation of multiple scans with manual part handling.

## Semi-automated CT Inspection

In semi-automated CT inspection systems, loading the part or a sample holder with multiple parts is the only manual operation. The remaining scanning and analyzing fail/pass process is completely automated.

### BENEFITS

- Custom, simplified user interface (UI) guides the user through the complete process
- Part identification by bar or QR code reader
- Integrated with manufacturing database
- Repeatable process



Semi-automated inspection allows automation of all tasks with multiple part loading.

## In-line CT Inspection

The in-line CT system is a 100% inspection solution for automated production environments where critical parts with complex internal geometries need to be inspected. Robots load/unload samples from conveyors and position parts in the CT system via an automated door.

### BENEFITS

- Integration with robot and conveyor systems
- Improved quality control
- Increased efficiency
- Complete traceability



In-line automation allows full integration of CT inspection to your production line.



## Versatile and easy-to-use electronics QA system

The XT V 130C is a highly flexible and cost-effective electronics and semiconductor inspection system. The system features a 130 kV/10 W Nikon Metrology manufactured source, a globally recognized open tube design with integrated generator, and a high-resolution imaging chain.

Through a series of factory and field upgrades, the end-user can configure these systems to its own needs with a higher power source, a rotating sample tray, automatic inspection software, a digital flat panel option, and the ability to add future-proof CT technology.

### FEATURES

- Proprietary 20-130 kV micro-focus source with 2  $\mu$ m feature recognition
- Measurement area of 406x406 mm
- True 72° manipulator tilting angle allows oblique viewing for easy inspection of internal features
- A hinged door providing easy access to the inspection area
- Serviceable components are easily accessible

### BENEFITS

- On-line operation with intuitive joystick navigation
- Low-cost maintenance with open-tube technology
- Safe system requiring no special precautions or batches
- Small footprint and low-weight for easy installation
- CT option possible

### APPLICATIONS

- Electronic and electrical components
  - Broken wedge bonds, lifted ball bonds, wire sweep, die attach, dry joints, bridging/shorts, voiding, BGA, etc.
- Populated and unpopulated PCBs
  - View surface mount defects i.e. misaligned devices, solder joint porosity and bridging
  - Detailed inspection of vias, through-hole plating and multi-layer alignment
- Wafer-level chip scale packages (WLCSP)
- BGA and CSP inspection
- Non-lead solder inspection
- Micro-electro-mechanical systems (MEMS, MOEMS)
- Cables, harnesses, plastics and many more



Easy access to the inspection area

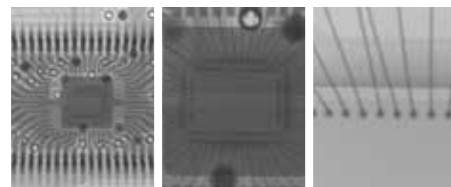

Superb image magnification enables users to zoom in on any specific item of interest

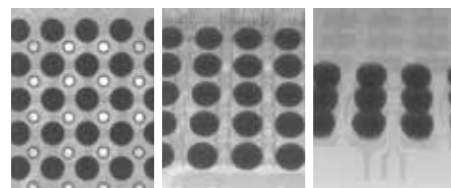

Tilt angles up to 72° offers sufficient flexibility to trace connectivity issues quickly

XT V 130C



## Top-class X-ray inspection system

Component connections on today's compact and densely populated PCBs are hidden by other components, making X-ray the only viable inspection solution. With sub-micron feature recognition, the XT V 160 is applicable to a wide range of industries, from PCB assembly, BGA, chip design, medical device, automotive component manufacturing, aerospace, consumer products and much more.

In automated inspection mode, samples can be inspected at the highest throughput. In manual mode, intuitive software and high-precision sample manipulation enable operators to visualize and evaluate the tiniest internal defects and deficiencies.

### FEATURES

- Proprietary 160 kV source with sub-micron feature recognition
- Over 90 degrees oblique angle viewing of BGAs
- Fast data capture and high-quality imaging
- Large tray for loading multiple boards
- Customizable macros automate measurement workflow
- Remote validation station available

### BENEFITS

- Patented Nikon Xi micro-focus X-ray source with open-tube design and unlimited life cycle, avoiding expensive replacements associated with sealed-tube technology
- True 16-bit amorphous silicon flat panel detectors for best in-class image quality
- Seamless transition between radiography, tomography and laminography in one system
- True concentric imaging - component stays in view at any combination of tilt, rotating and magnification
- 160 kV maximum energy, 20 W true-target power, over 2000x geometric magnification, up to 36,000x system magnification and 500 nm defect recognition capability. The XT V inspection systems house sample sizes up to 711x762 mm (28x30"), sample weight of 5 kg (expandable to 12 kg) and can image up to 56 fps
- C.Clear imaging engine - C-Clear imaging engine allows automatic, real-time image enhancement, so all users achieve superior image quality
- The XT V series come ready for Industry-4.0, with full control through IPC (Inter-Process Communication) for seamless integration to the production line

### APPLICATIONS

- Solder reflow analysis
- BGA connectivity and analysis
- Solder void calculation
- Through hole measurement and inspection
- Die attach voiding measurement
- Ball bond analysis
- Stitch bond analysis
- Micro BGA / chip-on-chip analysis
- Pad array analysis
- Dry joint detection and analysis
- Inspection of laminates, sensors, switches, and small electronic components

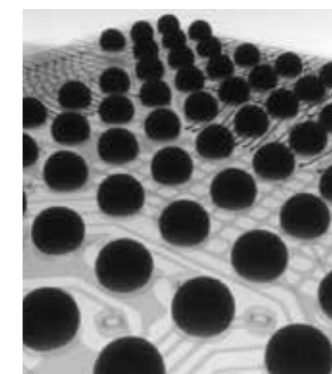

Under any combination of rotation, tilt and magnification, the region of interest is consistently locked into the center of the field of view

XT V 160

# Large Volume Metrology

APDIS LASER RADAR

SHOP FLOOR CMM



Nikon Metrology assists customers in delivering Quality 4.0 with shop floor and in-line capable technology. APDIS Laser Radar products allow for fast and accurate measurements of larger parts in situ or in the production line increasing quality, reducing scrap and improving the manufacturing process.

## Automated, non-contact, large volume inspection

The APDIS MV430 and MV450 Laser Radar systems are used for fast, automated and non-contact inspection of objects ranging from smaller components such as a car door to complete large assemblies such as commercial aircraft. It achieves this through a unique application of a non-contact, accurate laser based measurement technology overcoming the limitations of traditional monolithic or portable metrology systems. The ability to measure detail at distance, without the need for handheld probes, targets or surface preparation means APDIS is ideally suited for repetitive, complex, hard to reach, delicate and labor intensive inspection tasks, covering a huge range of manufacturing, industry and research applications.

APDIS LASER RADAR



The APDIS Laser Radar is used for large volume inspection of objects ranging from a car door to an entire aircraft, reducing costs and improving product and process quality.

### BENEFITS

- Measure parts in situ at high accuracy
  - Portable and shop floor suitable (IP54) with absolute accuracy
- Measure safely, with no part preparation
  - Non-contact laser technology at up to 50 m range on almost any surface
- Measure consistently with little or no labor
  - Automated measurements, no probes or adapters required, deskill complex metrology
- Measure more, improve productivity
  - Precision laser beam and fast feature measurement, augmented by an Enhanced high speed option for high measurement throughput
- Measure vibrations directly without sensors
  - Non-contact Laser based surface vibration measurements with Enhanced version up to 2000 Hz

### APPLICATIONS

- Automotive**  
Metrology room or shop floor deployments for components, BiW or complete vehicle inspections
- Aerospace**  
Body/wing join predictive shimming; engine nacelle inspection; Carbon fiber layup inspection
- Space**  
Parabolic antennae inspection; Satellite array measurement; Highly reflective/delicate material dimensional inspection.
- Energy**  
Wind turbine blade inspection; Reflector array alignment and positioning
- Manufacturing**  
In-line process control; Sheet metal inspection; Forged part inspection



# APDIS Automotive Shop Floor CMM

Utilizing non-contact laser-based technology, the APDIS Laser Radar can directly measure automotive features without the need for surface preparation or adapters making it ideal for fully automated measurements directly in the production line.

APDIS's long range and large standoff allows for measurements in all areas of the car body in absolute coordinates to HA CMM accuracy. Precision control of the beam creates optimized scan paths for features, keeping data sets small and measurement speeds fast.

The new APDIS MV430E 'Enhanced' model delivers the fastest ever Laser Radar, further increasing measurement throughput and productivity for automotive applications.



APDIS Laser Radar mounted on a robot is an innovative alternative for a traditional horizontal arm CMM

## BENEFITS

- Absolute Accuracy on the shop floor
- No off-line correlation
- Independent of robot accuracy
- Fully automated measurements
- High measurement productivity
- Fast feature measurements
- No part preparation or adapters
- Track quality real time
- Installation flexibility
- Metrology room or shop floor installation (IP54)
- Non-contact large stand-off for part safety
- Measure in any orientation for optimal feature access



Features like holes, slots, pins, studs etc are inspected in an automated way with precision scan paths and optimized data sets.

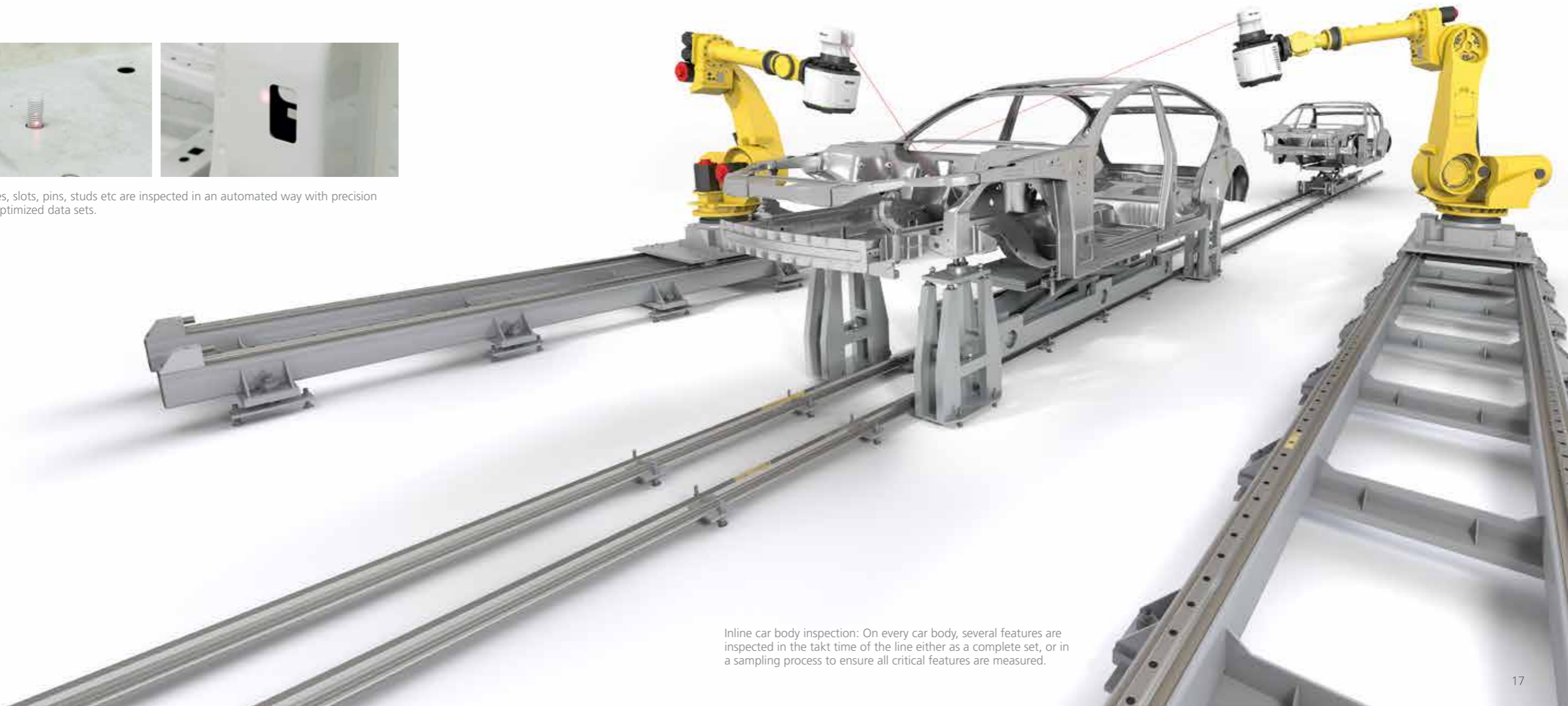

Inline car body inspection: On every car body, several features are inspected in the takt time of the line either as a complete set, or in a sampling process to ensure all critical features are measured.

## Driving Quality 4.0

As Body-in-White inspection moves in the direction of Quality 4.0, it needs to become a fully automated, absolute measurement process that is integrated into the production line.

Traditional inspection approaches, such as Coordinate Measuring Machines (CMMs), are being replaced by newer, non-contact and more flexible approaches like Laser Radar systems that can be integrated into the production line. The more regularly reliable measured data is provided, the more tightly production line quality can be controlled. This is especially true in car plants, where the increase in part and process quality is effective in pre-series, ramp-up and production build phases, ultimately leading to a much shorter time-to-market for a new vehicle.



Inline inspection: the APDIS MV430E provides the fastest feature measurements of any Laser Radar, allowing inspection of critical features directly within the production line



Bypass inspection: By automatically removing a car body from the line, detailed inspection is possible on vastly more components than previously possible. After inspection, the body is automatically re-inserted into the production line for seamless integration.



Metrology room: Using APDIS in the metrology room as a replacement for traditional CMMs, the off-line facility ceases to be a bottleneck due to faster measurements allowing quicker problem investigation.



Component inspection: Incoming part inspection is critical to avoid assembly issues further down the production line. The APDIS Laser Radar allows for fast, non-contact feature and surface inspection on components from doors to bodysides, to have an instant quality report on components from external suppliers.

### What customers gain

With the need for shorter and more flexible product development cycles, automotive manufacturers are continuously looking to cut time and costs whilst maintaining quality. For automotive inspection, the APDIS Laser Radar offers the ideal capabilities to meet the need for flexible and absolute measurements directly on the shop floor. For automotive manufacturers this results in:

**FASTER TUNING OF NEW PRODUCTION LINE OR VEHICLE MODEL CHANGES:** APDIS provides CMM quality, absolute data on the shop floor from day 1. This allows production ramp up much more quickly with production line, absolute and accurate measurement data available on each body run down the line during pre-series builds.

**IMPROVED PROCESS CONTROL:** True dimensional quality control at the Body-in-White assembly line, provided by the APDIS Laser Radar, detects product and process anomalies as they occur in the production process. This helps to control the assembly process in such a way that dimensional tolerance targets are hit consistently. The result is not only better fitting of closures, trim, seating and other components in downstream assembly resulting in less rework, but also a production process that continuously improves.

**FUTURE PROOF DATA:** Measurements in absolute coordinates fit in the digital manufacturing process where big data is used as a reference to compare data over time and enabling enhanced insight, decision making, process automation and to speed up future product development.

# Video Measuring Systems

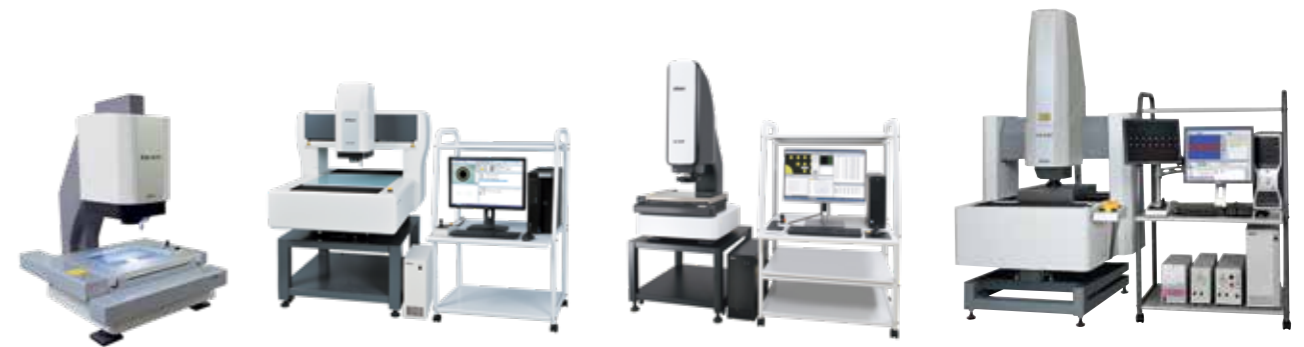

Precision metrology instruments ensure the finest quality assurance throughout production. Founded on Nikon's optical excellence, video measuring systems set new standards for measuring even the smallest of work pieces.



iNEXIV VMA-4540

## Multi-sensor CNC video measuring systems

NEXIV CNC Video Measuring Systems automatically inspect the dimensions of a variety of components from fine precision equipment and electronics parts, using optical measuring and use of image processing technologies. By precisely detecting the feature edges of the sample using CCD camera images and with data processing, the measurement of a complex sample is possible.

Starting with the VMA-2520 as a lightweight and compact multi-sensor measuring system for fast, fully-automatic and high-accuracy component measurement. It is ideally suited for a wide variety of industrial measuring tasks, inspection and quality control applications. The VMA-2520 is designed to measure 3D work pieces, is touch probe ready, integrates the latest imaging processing software, and incorporates a superb Nikon 10x optical zoom system and laser autofocus by triangulation option.

The cost-effective VMA-4540 offers a larger measurement stroke enabling inspection of both larger and taller mechanical and electronic parts. The VMA-4540 additionally provides optional touch probe measurement capability. The largest stage travel model, the VMA-6555 is suitable for the largest samples (up to 650 x 550 x 200 mm) and can be configured for serial measurement of multiple parts when loaded together. It features optimal cost-performance with the same strong cast iron body construction and uses the same direct bearing technology as the high-end models.



iNEXIV VMA-6555 large stroke model



Aluminum die casting part



iNEXIV VMA-2520



VMZ-S3020



VMZ-S4540



VMZ-S6555

## The latest advancements in NEXIV technology

Accurate measurements of advanced products (i.e. automotive electronics and semiconductors) and high-speed image processing technology for mass production have become a standard inspection operation. These next-generation NEXIV systems aim for the fastest and more accurate measurement of component dimensions and shapes of even high density, multi-layered electronic components and mechanical parts.

### HIGHLY ACCURATE AND FAST MEASUREMENTS

A higher level of accuracy in measurements is achieved by Nikon's in-house developed linear encoder technology. Improvements to the image transfer technology and changes to the illumination sources have together significantly shortened overall measuring time.

### MEASUREMENT FLEXIBILITY

A third ring illumination angle enables advanced edge detection, while enhancements to the Through The Lens (TTL) Laser Autofocus have strengthened the system's ability to measure even transparent components.

### ADVANCED OPERABILITY

Work efficiency has improved by reducing the number of program steps needed to create teaching files. Developed for an easier understanding and better comprehension, the newly added "Guide Panel" function has improved the main program for the system operator.

### 8-SECTOR RING LIGHT SYSTEM WITH THREE INCIDENT ANGLES

Episcopic, Diascopic and the Ring illumination all employ high energy output white LEDs and providing excellent contrast stability and a very long light source life. The Ring Light System with its three incident angles is designed for correct edge capture and high confidence over repeated measurement cycles.



Low incident angle / Long WD High incident angle / short WD

New 8-sector Ring Light system with its three incident angles is designed for even better edge capturing capability.

### FEATURES

- High accuracy within the field of view (FOV). Accuracy within FOV (PF2D,PFV2D) is specified (VMZ-S)
- Throughput has improved by realizing faster short-distance stage movements, contributing to the shortening of the measurement time (VMZ-S)
- Laser Autofocus (on-axis) is designed to detect with ease even the surface of thin transparent materials
- 6 types of optical zoom systems are available in the model series
- 8-sector Ring Light LED illumination systems with three repeatable incident angles to control image contrast
- Improved measuring accuracy with high resolution linear encoder technology
- Available in different stage sizes VMZ-S3020, VMZ-S4540, VMZ-S6555
- Streamlined software user interface enables every user to operate the system and create automated measurement programs across a range of skills and experience

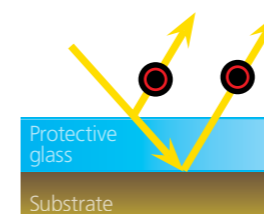

New Laser Autofocus is designed to detect surfaces of thin, transparent material. The new sensor detects both top and back surfaces.

iNEXIV VMA SERIES

NEXIV VMZ-S



## 3D measurements using confocal images

The Confocal NEXIV series demonstrates a ground-breaking multi-functional video measuring system that was developed from the strength of Nikon's leading opto-mechatronics experience and technologies.

The VMZ-K model incorporates advanced confocal optics for fast and accurate evaluation of fine three-dimensional geometries, and bright field optics with a 15:1 zoom ratio. The live confocal image provides an exceptional view of the sample surface with an extended depth of focus to the operator and for the system's measuring algorithms. It allows both 2D and height measurements to be made in the same field of view. The Confocal NEXIV can be optimally used for the inspection of highly complex structures such as solder bump heights on advanced semiconductor packages, wafer probe cards and laser markings fabricated onto wafers, etc.

### FEATURES

- Simultaneous wide-area height measurements with Nikon's proprietary confocal optical design
- 2D measurement with the 15:1 bright field zoom ratio optics
- Fully compatible with 300 mm wafer measurement tasks
- Available across different stage sizes: VMZ-K3040 and VMZ-K6555

### APPLICATIONS

- Solder Bumps on advanced IC packages and new layout designs
- Wafer Probe cards
- Precise optical components (micro lens, contact lens)
- Laser marking on semiconductor wafers
- Micro-Electro Mechanical Systems (MEMS)
- Wire bonding integrity and position checking

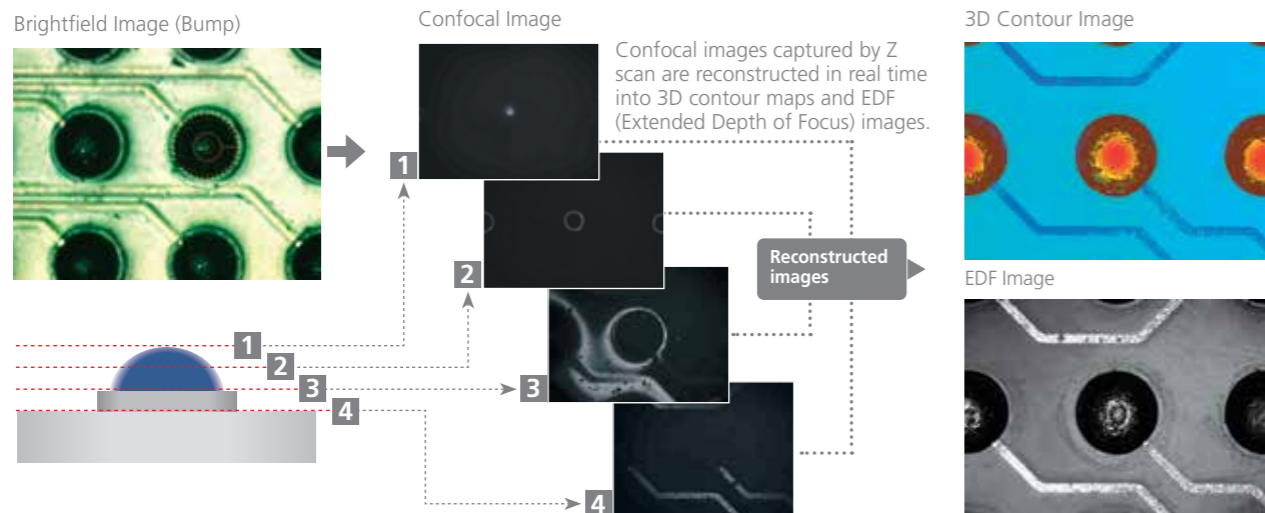

# Manual Measuring Instruments

MANUAL MEASURING MICROSCOPES

PROFILE PROJECTORS

DIGITAL HEIGHT GAUGES

AUTOCOLLIMATORS



Precision metrology instruments ensure the finest quality assurance throughout production. Founded on Nikon's optical excellence, measuring microscopes, profile projectors and optical comparators set new standards for measuring even the smallest of work pieces.

## Integrating digital imaging with industrial metrology

Nikon's measuring microscopes offer performance, convenience and an unprecedented degree of flexibility for upgrading and expansion in future.

The MM400/800 Series delivers complete digital system control for maximum measuring accuracy in demanding industrial environments. Measuring microscopes are excellently suited to inspect measure and verify 2D and 3D features on small or medium sized parts.

The MM-200 is a compact and lightweight measuring microscope system with an affordable price for applications that require high precision and good accuracy for measuring a variety of metal, plastic and electronic parts across all industries; especially suited for automotive and electronics components.

**FEATURES**

- Seamless integration with Nikon's digital cameras and E-Max metrology software
- High-intensity white LED illuminators are standard for bright field feature imaging use
- Backpack electronics interface facilitates control of the automated illumination, XY stage and Z axis data control through an external computer running Nikon's E-Max software
- For larger work piece measuring, a stage up to 12x8 inch travel is available

**BENEFITS**

- Excellent geometric data capture, processing and storage
- Ease of operation greatly improved through the various automated motorized controls and an ergonomic design
- Added body strength allows for using larger stages without system distortion
- Expanded observation range by offering many options in illuminators optical configurations and illumination light sources
- A fully motorized high-magnification compound microscopy model is also available for extremely fine digital imaging capability

**APPLICATIONS**

- Medical device Lab-on-a-chip technologies
- Micro Electro- Mechanical Systems (MEMS)
- Plastic component manufacturing (e.g. injection moulded parts)
- Medical devices for intravascular and general in- body activity e.g. replacement hip and knee joints
- Microelectronics and optoelectronics
- Micro tooling devices
- Surface analysis by roughness or to investigate failure analysis
- Cracks in materials & gross failure analysis studies

**RELATED SOLUTIONS**

- NEXIV and iNEXIV video measuring systems
- Industrial microscopes



MM800LMU + LED EPI lamphouse

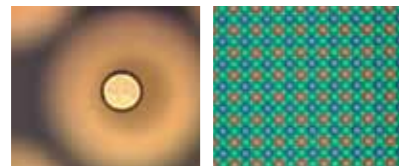

PGA - Insertion pin CCD

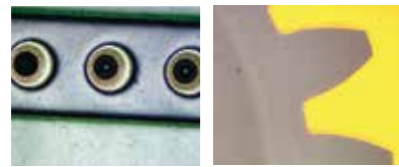

Brightfield image Plastic gear teeth



MM-200

MM-400

## Unrivalled precision, unmatched performance

### Profile projectors

Nikon's profile projectors apply the principles of optics to the inspection of manufactured parts, by projecting the magnified silhouette of a part on a screen. To suit your specific application, each profile projector comes with multiple projection lenses, each featuring a different magnification, working distance and field of view size.

The V-20B has a large effective screen diameter of 500 mm. Its superior magnification accuracy is ideal for measuring and inspecting profiles, surface conditions and other aspects of large workpieces.

The Horizon line of horizontal benchtop comparators yield powerful, reliable illumination for surface and profile inspection and measurement.



V-20B

V-12B

**APPLICATIONS**

- Profiles (metal and plastic manufacturing)
- Surface conditions
- Other part aspects
- Crack and failure analysis

**RELATED SOLUTIONS**

Different profile projector types are available:

- V-20B (Screen diameter 500 mm)
- V-12B (Screen diameter 300 mm)
- Horizon 16E (Screen diameter 400 mm, only for USA)

### MF-1001/MF-501 Digimicro

The MF-1001 and MF-501 Digimicro series offer flawless contact measurements of dimensions, thickness and depth. They feature measuring length equal to 100 mm and 50 mm respectively and accuracy of 1 µm at 20°C. Stands are available in ceramic, steel or granite for added stability and a wide variety of probe tips are available to suit most applications



MF-1001 digital height gauge

MF-501 digital height gauge

### 6B/6D-LED Autocollimators

Nikon Metrology's autocollimators check alignment and measure very small angular deviations to measure flatness or height by simple geometry. Darkfield model autocollimator is perfect for measuring small, flat mirrors. Brightfield model autocollimator utilizes hallmark Nikon optics to illuminate surface details.

Applications involve surface flatness inspection, alignment of components with reflective surfaces (e.g. CD player pickup lens) as well as measurements related to machine tools (e.g. straightness in movement of stages, angles of indexers).



Industrial microscopes  
Complete range of stereoscopic microscopes

# Materials and Industrial Microscopy Solutions

STEREOSCOPIC MICROSCOPES

MATERIALS AND INDUSTRIAL COMPOUND MICROSCOPES

SCANNING ELECTRON MICROSCOPES

SOFTWARE SUITES



As a world leader in imaging technology, Nikon manufactures complete optical and digital microscope systems with outstanding versatility, performance and productivity for any application.

STEREOSCOPIC MICROSCOPES



SMZ25



SMZ18

## A giant step forward for stereo microscopy

The SMZ25 and SMZ18 models are revolutionizing stereo microscopy with their world beating 25:1, and a 18:1 zoom ratio. The 25:1 zoom ratio represents around 25% more zoom range than the nearest alternative large-zoom stereo microscope. You may expect excellent accessory modularity, user comfort and a range of ultra-high performance optics.

These new top of the range SMZ models cover a wide range of functionality, from challenging stereoscopic applications to provide images of un-paralleled quality to the finest resolvable detail.



Injection needle



Printed circuit board (brightfield)



Printed circuit board (fluorescence)



Watch

### FEATURES

- World's largest zoom range of 25:1 for the SMZ25 and highest resolution in all of the Nikon SMZ series
- Motorized focus and zoom operation (SMZ25)
- Crystal clear stereoscopic and digitally captured images
- Easy-to-operate slim LED DIA bases with an OCC illumination (oblique lighting method developed by Nikon) for transparent materials



SMZ1270i

The SMZ1270/SMZ1270i is a stereo microscope model range with the largest zoom ratio in its class. The SMZ800N excels by featuring enhanced optics and operability for routine applications, whilst retaining excellent imaging capabilities.

These stereo microscopes enable researchers to carry out challenging high-magnification, large-zoom-ratio stereoscopic studies alongside high-definition image capture and quantification with ease. The clarity of the images and improved ease-of-use design benefit researchers in a variety of material science and industrial fields.

The complete line up of Nikon stereomicroscopes covers the full range of functionality expected by microscope users from sophisticated observation to more affordable models and all with the ergonomic features required today in the workplace.



SMZ800N

**HIGH-QUALITY IMAGES**

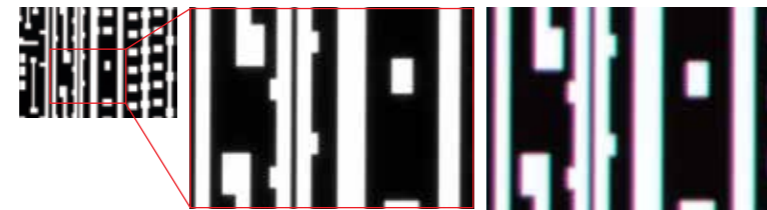

Apochromat optics  
(captured with SMZ1270+  
Plan Apo 1x/WF)

Conventional optics



SMZ745T

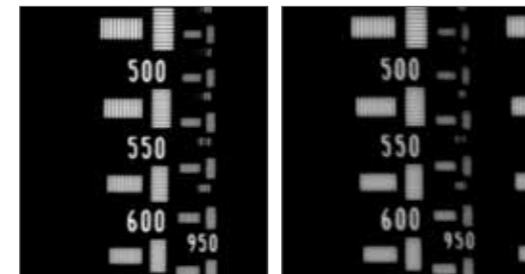

SMZ800N

Conventional model



SMZ445

**OBJECTIVES OPTIMIZED FOR WIDEFIELD OBSERVATION AT LOW MAGNIFICATION**



- SMZ 25/18
- SMZ 1270i/1270/800N
- SMZ 745/745T
- SMZ 445/460
- SMZ-2

At the forefront of optical innovation

Nikon Metrology offers a complete portfolio of industrial compound microscopes for a wide range of applications, from basic models to sophisticated systems for high-end sample or component inspection. The Nikon Eclipse range featuring optical and digital microscope systems offers the outstanding versatility, performance and productivity required to tackle practically any application with ease.



Eclipse LV100ND

**SMALL-FOOTPRINT ECLIPSE LV100N SERIES DELIVERS SUPERB OPTICAL IMAGE QUALITY WITH ERGONOMIC FEATURES**

Nikon's Eclipse microscopes are renowned for their ability to deliver for the user clearer images with a higher contrast. The LV100N delivers these brighter images, with lower power consumption and less heat generation from the light source, thereby reducing the chance of heat-induced focus drift.



Eclipse LV150N

**LV150N FOR INDUSTRIAL INSPECTION**

The Eclipse LV150N Series microscopes provide superb performance when inspecting semiconductors, flat panel displays, electronics packages, electronics substrates, resin mounted, cross sectioned and polished materials, medical devices, and a great variety of other samples.



Eclipse L200N

**L200N FOR INSPECTING 200 MM WAFERS AND MASKS**

Combined with Nikon's superior CFI60-2 optical system design concept and an extraordinary new illumination system, this microscope provides brighter images with greater contrast over large diameter samples. The L200N series is designed to be ideally suited for the inspection of wafers, photo masks and other substrates.



Eclipse L300N

**L300N FOR LARGE-SIZE FLAWLESS INSPECTION OF LCDS AND WAFERS**

Configured for 300 mm wafer and mask inspection, the Eclipse L300N Series also satisfies the need for flat panel display backend electronics materials inspection. The L300N Series utilizes Nikon proprietary CFI60-2 optical system, offering exceptionally high resolution, and high contrast images.



MA100N



Eclipse MA200



Wafer loading system  
NWL200

### ECLIPSE MA200 / MA100N INVERTED METALLURGICAL MICROSCOPE

MA200 is an inverted metallurgical microscope optimized for digital imaging and ergonomic efficiency. Its unique cubic box design allows easy access and line of sight to the sample on the stage and to the nosepiece, with a desk top footprint, one third of the area of a conventional model. The Eclipse MA100N is a compact-size inverted microscope unit developed for high quality bright field observation and simple polarizing contrast. The MA100N uses the same Nikon optic range as the larger stands to maintain an excellent image quality.

### NWL200 WAFER LOADER FOR NIKON ECLIPSE IC INSPECTION MICROSCOPES

The NWL200 is capable of loading down to 200 micron thin wafers. The new loading system achieves highly reliable loading suitable for inspection of next-generation semiconductors.

#### RELATED SOLUTIONS

- Modular Microscopy design concept provides a huge choice of accessories (e.g. illuminators, objective lenses, stages, wafer loaders) to help meet the inspection requirements seen today
- Availability of microscope variants in each series for dedicated inspection purposes (e.g. polarizing capability, high end metallurgical use)
- Availability of motorized nosepieces and cameras for digital imaging



Microscope cameras



## Ultra high vertical resolution of 1 PicoMeter

BW-S series measure surface profiles from sub-nano to millimeter height ranges speedily and accurately.

- High accuracy and repeatability - calibrated by an 8 nm or 8 μm VLSI Step Height Standards sample, certified by NIST
- High-precision/high-speed image - acquisition via a two beam interference objective lens
- 1 pm height resolution achieved at magnifications from 2.5x to 100x
- Wide region configuration analysis with stitching
- Six models available to match application and cost

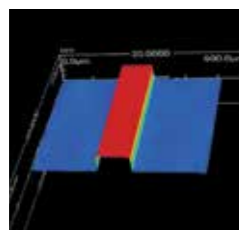

VLSI Step Height Standard:  
8 nm

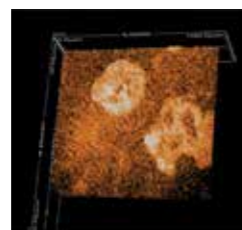

The Planarized SiC Wafer

## The next-generation of bench-top scanning electron microscope



The JCM-7000 Neoscope has highly-advanced auto image optimisation functions, sample stage automation, and a dedicated software environment to enable easy sample image capture and an optional full area chemical elemental analysis in real time for users of all experience levels. Equipped with a large sample vacuum chamber, high, low, and charge free vacuum modes of operation are provided as standard.

#### FEATURES

- Zeromag - Simplifies navigation and enhances throughput by providing a seamless transition from a color camera image (option) or holder graphic to the live SEM image.
- Montage - The ability to set up automated image stitching and automated montage EDS maps.
- Multiple live imaging modes - Simultaneous SE and BSE imaging and includes signal mixing with user control of contribution from each detector.
- Easy installation - This system is compatible with standard electrical outlet (no special circuit required).
- SmileView™ Lab - Central data management software links the SNS (optical) image, SEM images and EDS analysis results and locations. Smart report layout.

#### BENEFITS

- Improved work efficiency
- Seamless transition from Optical to SEM imaging
- Seamless transition from SEM imaging to EDS Analysis
- Simple report creation and data management

Both secondary electron detector (SED) of Everhart Thornley design and a Solid – state, multi segment backscatter electron detector (BSED), are provided as standard equipment. The BSED additionally provides a real-time 3D profile imaging capability.

Alongside image capture a set of easy to use measuring tools are provided as standard. For the optional EDS Chemical elemental analysis detector, a most capable and fully integrated control system provides a state of the art solution in the desktop unit comparable to systems on large column SEM units.

Benchtop SEMs may be used across a wide range of fields, including as examples: electrical component inspection, raw material purity by chemical studies in pharmaceutical industries. Plant material alongside textiles, paper, pigments studies, forensic and conservation studies. In addition, SEM applications are expanding to not only cover research and development, but also address quality control and product inspection close to the production line for failure analysis investigations. With these applications, demands for further improved work efficiency, easier operation, and a higher degree of analytical and measurement capabilities, are increasing and addressed well by the JCM-7000 unit.



# Software solution overview

INSTRUMENTS SOFTWARE

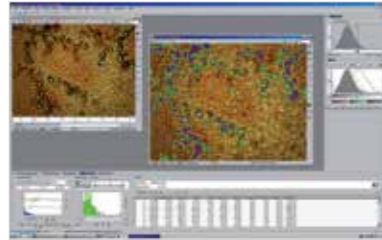

## Nikon NIS elements software suite

### COMPREHENSIVE DEVICE CONTROL AND IMAGE ANALYSIS, VISUALIZATION AND ARCHIVING TOOLS FOR MICROSCOPY

NIS-Elements suite revolutionizes imaging software activities for the microscopy market by combining automated intelligence functions to microscopes, cameras, components and peripherals with powerful analysis, visualization and archiving tools. Its intuitive interface simplifies workflow and speeds up image acquisition times whilst providing a full and versatile range of features, such as image stitching, object counting, area fraction and volume views and quantification.



## Auto Measure for NEXIV

### USER-FRIENDLY SOFTWARE THAT MAKES VIDEO METROLOGY MEASURING AND AUTOMATION SIMPLE

Auto Measure integrates an intuitive wizard menu, customizable GUI and engineer/operator mode within a multiple-language environment to provide a fully functional solution for today's industrial requirements. Auto Measure software supports both the iNEXIV VMA and NEXIV VMZ-S/VMZ-R video measuring systems.



## AUTOMEASURE EYES (iNEXIV)

Auto Measure Eyes package features easy user operation with measurement programs that can be Created and stored with just a few mouse clicks. It also features comprehensive reporting functions to obtain and record fully captured data to fully interpret and present an insight into product quality.



## E-Max Series of data processing software (Measuring instruments)

### FOV MEASUREMENT WITH ADVANCED DIGITAL IMAGING PROCESSING TECHNOLOGY

The E-MAX series software offers state-of-the-art image processing that supports general-purpose measurement for a wide range of manual measuring instruments, including Nikon's measuring microscopes and profile projectors.

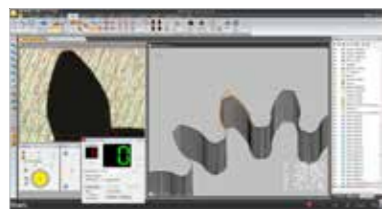

## CMM-Manager for NEXIV

### EXPAND THE CAPABILITIES OF MULTI-SENSOR MEASUREMENT

Expand your Nexiv's 3D tactile and video measuring capabilities with CMM-Manager, now available on the Nikon iNEXIV touch probe capable measuring instruments. CMM-Manager is task-oriented, highly intuitive and offers powerful measuring and reporting capabilities. Main product features include collision-free CAD-based path definition, virtual path simulation and accurate feature measurement for both tactile and vision probing.



# Multi-sensor Metrology

CMM LASER SCANNING

HANDHELD LASER SCANNING

METROLOGY SOFTWARE



L100



LC15Dx



XC65Dx-LS



ModelMaker H120



MCAxS

## Laser scanning boosts inspection performance



### L100 – The ultimate CMM laser scanner combining productivity and accuracy

The L100 CMM laser scanner offers the best possible combination of speed, accuracy and ease-of-use. Suited for both surface and feature measurement, the L100 quickly delivers accurate data and insightful part-to-CAD comparison reports even on shiny or multi-material surfaces.

The L100 is ideal to inspect larger components where productivity is key, but without having to compromise on accuracy. Equipped with a high quality glass Nikon lens and a high definition camera, the L100 features a point resolution of 42 µm and an exceptional data accuracy, enabling delivery of smooth meshes and high levels of detail.



### LC60Dx – All-purpose CMM scanner for every budget

The LC60Dx is an all-purpose scanner is designed for effortless scanning of varying or hard-to-scan surface materials. Like all other Nikon laser scanners, the LC60Dx is equipped with the unique Enhanced Sensor Performance capability, providing real-time, point per point laser intensity adjustment that constantly adapts to the material surface.

The all-purpose LC60Dx is Nikon Metrology's entry level laser scanner, and is ideal for limited budgets.

## Benefits of CMM-based laser scanning

### BETTER INSIGHTS INTO DEVIATIONS

- Leads to faster decision-making and corrective actions
- Results in fewer and shorter design iterations and faster time-to-market
- Shortens production downtime through faster troubleshooting

### ENHANCE THE CAPABILITY OF YOUR CURRENT CMM

- Upgrade to a versatile multi-sensor CMM offering both non-contact and touch probe inspection
- Retrofit existing CMMs controller hardware and software. Retrofit kits are available for most leading CMM controller brands

### INCREASE INSPECTION PRODUCTIVITY

- Laser scanners collect more information in less time
- Faster feature measurement due to fewer CMM movements
- Easy off-line CAD-based programming saves on preparation and modification of measurement programs

### MEASURE ANY MATERIAL

- Measure soft or delicate materials with non-contact technology to avoid deformation of sensitive parts
- Automatic laser adjustment means dark or shiny parts and materials can be measured without special treatment

## Full 3D capture of features and complex surfaces



### LC15Dx – Closing the gap with tactile accuracy

The LC15Dx scanner brings 3D digitizing within the accuracy range of tactile measurement, while offering the advantage of capturing thousands of points rather than a few discrete touch-probed points. In tests comparable to ISO 10360 the LC15Dx achieved the accuracy expected when using a CMM with a tactile probe.

With its custom-built Nikon lens and a point resolution of just 22 µm, it perfectly suits digitizing small or detailed objects. Very high point density and the ability to satisfy tight tolerances make it the ideal tool for inspecting parts such as small blades, gears and medical implants.

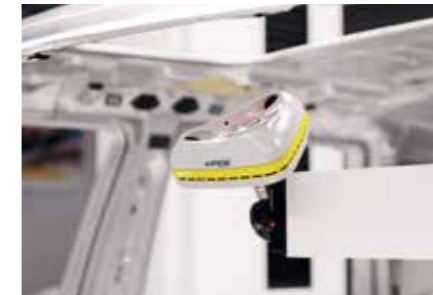

### XC65Dx(-LS) Cross Scanner – Productive feature inspection

Incorporating a patented design with 3 lasers in a cross pattern, the XC65Dx captures full 3D details of features, edges, pockets, ribs and freeform surfaces in a single scan. As such it sets new productivity standards by acquiring data at a faster pace while driving the accurate extraction of positions and dimensions.

The XC65Dx-LS has a longer stand-off for optimal capture into deep pockets and slots, and accessing other hard-to-reach locations. The Cross Scanner is suited for inspection of sheet metal vehicle body parts with 2D or 3D features, casted engine parts and complex plastic molded parts etc.

### SPECIFICATIONS

	L100	LC15Dx	LC60Dx	XC65Dx	XC65Dx-LS
Field-of-view	110x60 mm	18x15 mm	60x60 mm	65x65 mm (3x)	65x65 mm (3x)
ISO probing form error	15 µm	7 µm	20 µm	25 µm	35 µm
Data acquisition (approx. pts/sec)	200,000	70,000	77,000	3 x 25,000	3 x 25,000
Resolution	42 µm	22 µm	60 µm	93 µm	93 µm

# Ultra-fast high-definition 3D scanning

Nikon Metrology's premium ModelMaker H120 laser scanner and MCAx S 7-axis articulated portable CMM arm form a leading-edge 3D measurement solution, enabling users to accelerate their time-to-market and streamline their manufacturing processes.

The MCAx S arm range comprises three performance levels at six different sizes and is compatible with tripods and magnetic bases for use in the metrology lab, on the shop floor or in the field. Unrestricted reach in and around parts at extreme precision while delivering high speed wireless scanning provides versatility, simple operation and efficiency in any environment.

ModelMaker H120 innovations such as bespoke Nikon optics, advanced calibration and patented automatic optimisation of settings for every single measured point with no reduction in speed; guarantee high productivity and superior non-contact measurement of freeform and geometric surfaces without compromising on small details – no matter the size or material.

## FEATURES

### MODELMAKER H120

- Blue laser technology
- Ultra sharp Nikon lens
- Stripe width up to 120 mm
- Extremely fast frame rate of over 450 Hz
- Scanner accuracy up to 7 µm (1σ)
- Combined ISO 10360-8 Annex D system accuracy with the MCAx S arms from 41 µm
- Enhanced Sensor Performance (ESP4) enables measuring difficult materials such as carbon fibre, gloss black, reflective or significantly multi-coloured parts

### MCAx S ARTICULATED ARM

- 7-axis articulation with infinite rotation and flexible probing options
- Available in lengths between 2.0 and 4.5 m and three accuracy levels (S, S+ & S++)
- Advanced construction: aerospace grade carbon fiber arms - strong but light with lifetime warranty
- ISO 10360-12 certified
- Optional wireless connectivity and battery power for arm and scanner

### APPLICATIONS

- Full part-to-CAD inspection
- Inspection of geometric features
- Gap & flush inspection
- Reverse engineering
- On-site troubleshooting
- Input for rapid prototyping



Enhanced scanning with the ModelMaker H120

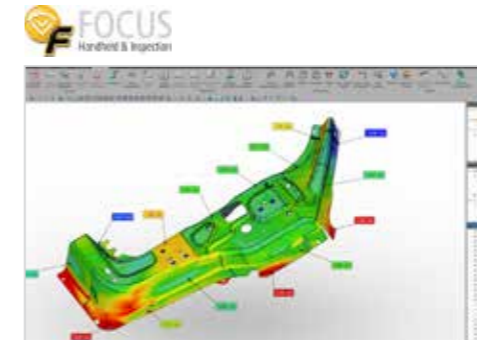

Nikon Metrology Focus Scan & Inspection

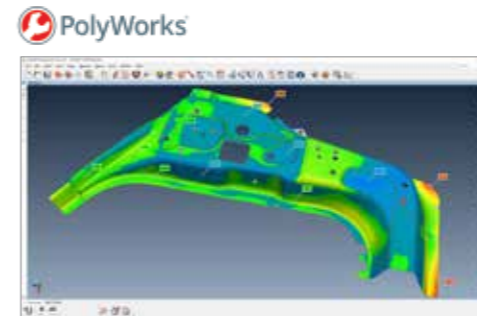

InnovMetric Polyworks



Metrologic Metrolog X4



3D Systems Geomagic

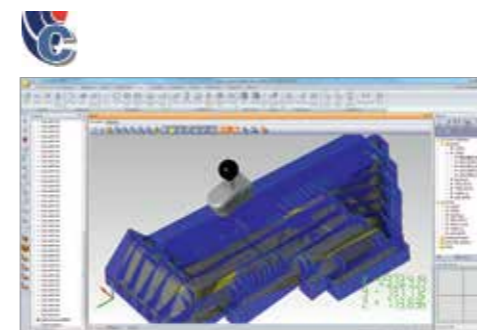

LK Metrology CAMIO

# 3D scanning metrology software

Advanced metrology software drives the digital inspection process

A comprehensive 3D inspection suite is at the core of this process quickly providing easy-to-interpret part-to-CAD comparisons and advanced feature inspection.

Seamless interaction between Nikon Metrology's sensors and the powerful metrology software delivers high productivity results from laser scanners on CMMs or articulated arms. This includes multi-sensor capability to use tactile or other probing technology in a single interface, including off-line preparation to automate CMM scanning tasks or pre-define measurement routines.

Nikon Metrology provides integrations with several major metrology software suites. This allows users to operate CMMs or articulated arms with the software of their choice. The integration level depends on the software package and spans online/offline programming, full-featured native acquisition, CAD/non-CAD based inspection, tactile probing and laser scanning.

Using the software that you are already familiar with, or that is best suited for your application simplifies training needs, while maximizing throughput and return on investment.

## SOFTWARE BENEFITS

- All suites have multi-sensor capability, combining tactile measurements with laser scanning measurements to best leverage the strengths of each sensor technology.
- Perform handheld inspection directly from within your inspection software. Software guides operator and gives direct feedback.
- CMM laser scan or tactile data acquisition with the possibility to do off-line part program preparation from CAD.
- Dimensional metrology with feature measurements and part-to-CAD inspection easily identifies quality issues.
- Comprehensive toolsets for wide-ranging quality evaluation needs such as GD&T, 2D sectional inspection, gap & flush checking, complex alignments, virtual assembly, edge analysis, statistical process control...
- Reverse engineering capabilities to digitally capture and refine design and styling intent.

# Customer Support



Nikon Metrology provides ISO9001/2000 accredited metrology solutions to a wide range of industries and bluechip customers in a global marketplace, utilizing a worldwide network of highly trained metrology experts. The complete range of services including helpdesk support, training, maintenance programs, retrofit capabilities and contract work, enables our customers to get the maximum value out of their Nikon Metrology solutions or to solve their inspection issues in the shortest possible time.

## HELPDESK

Instant help – the skills and technical knowledge to solve your application/software problems by dedicated helpdesk engineers.

## METROLOGY TRAINING/SEMINARS

Knowledge base – on-site/off-site, basic, intermediate and advanced software and hardware training and seminars using dedicated staff with hands-on experience.

## PROGRAMMING CONSULTATION

Operational assistance - highly-skilled engineers provide part programs or programming consultation - expertise which can reduce your product inspection costs.

## MAINTENANCE AND CALIBRATION

Technical service – the manpower, state-of-the-art technology and logistics to maximize reliability, uptime and equipment performance.

## SUB-CONTRACT INSPECTION

Nikon Metrology offers a wide range of subcontract inspection work. The broad product portfolio includes the right tool for every inspection challenge of the customer. On top of Nikon Metrology own inspection service facilities, Nikon Metrology also has a broad worldwide network of Nikon Metrology Service Centers, that are accredited by Nikon Metrology to perform contract inspection work.

- Laser scanning work for part-to-CAD inspection or Reverse Engineering
- X-ray and CT inspection work for electronics and industrial applications

## UPGRADES AND RETROFITS

Existing CMMs can be upgraded with an innovative Nikon Metrology scanner and application software. This considerably improves the inspection productivity and broadens the application scope. A full range of scanners and application software is available to meet all of your current and future needs.





**NIKON CORPORATION**

Shinagawa Intercity Tower C, 2-15-3, Konan,  
Minato-ku, Tokyo 108-6290 Japan

Tel: +81 3 6433 3701 Fax: +81 3 6433 3784

[www.nikon.com/products/industrial-metrology/](http://www.nikon.com/products/industrial-metrology/)

**NIKON METROLOGY EUROPE NV**

Interleuvenlaan 86  
B-3001 Leuven, Belgium  
Tel: +32 16 74 01 00 Fax: +32 16 74 01 03  
Sales.Europe.NM@nikon.com

**NIKON METROLOGY UK LTD.**

UNITED KINGDOM Tel: +44 1332 811 349  
Sales.UK.NM@nikon.com

**NIKON METROLOGY SARL**

FRANCE Tel: +33 1 60 86 09 76  
Sales.France.NM@nikon.com

**NIKON METROLOGY GMBH**

GERMANY Tel: +49 211 45 44 69 51  
Sales.Germany.NM@nikon.com

**NIKON INSTRUMENTS S.P.A.**

ITALY Tel: +39 055 300 96 01

**NIKON METROLOGY, INC.**

12701 Grand River Road, Brighton,  
MI 48116 U.S.A.  
Tel: +1 810 220 4360 Fax: +1 810 220 4300  
Sales.NM-US@nikon.com

**NIKON METROLOGY - MÉXICO**

MEXICO Tel: +52 442 688 5067  
Sales.NM-MX@nikon.com

**NIKON INSTRUMENTS (SHANGHAI) CO. LTD.**

CHINA Tel: +86 21 6841 2050 (Shanghai branch)  
CHINA Tel: +86 10 5831 2028 (Beijing branch)  
CHINA Tel: +86 20 3882 0551 (Guangzhou branch)

**NIKON INSTRUMENTS KOREA CO. LTD.**

KOREA Tel: +82 2 2186 8400

**NIKON SINGAPORE PTE. LTD.**

SINGAPORE Tel: +65 6559 3651  
NSG.Industrial-sales@nikon.com

**PT. NIKON INDONESIA**

INDONESIA Tel: +62 267 864 3949  
PTN.Instruments@nikon.com

**NIKON SALES (THAILAND) CO., LTD.**

THAILAND Tel: +66 2633 5100

ISO 14001 Certified  
for NIKON CORPORATION

ISO 9001 Certified  
for NIKON CORPORATION  
Industrial Metrology Business Unit

More offices and resellers at [www.nikonmetrology.com](http://www.nikonmetrology.com)