



Ready for an automated  
production environment,  
with autoloading and  
robotic integration  
capabilities available



# POWERFUL AND AUTOMATION-READY VOXLS 30 SERIES

# Powerful and Automation-Ready: Nikon's VOXLS 30 Series

Nikon has changed the world of enterprise inspection with the launch of the new VOXLS 30 Series, CT systems optimized for automated industrial quality control and designed to help customers achieve zero-defect manufacturing.

At the core of the VOXLS 30 Series system is an expertly designed, metrology-grade manipulator set on a vibration-damping and thermally stable granite base. This rock-solid foundation enables exact and repeatable part positioning within the system's expansive scanning envelope which is greater than 600 mm (Ø) x 1,000 mm (H), with a system capacity of 1,000 mm (Ø) x 1,300 mm (H). This empowers the VOXLS 30 Series to generate stunning image clarity.

Thanks to unrivalled visibility, users gain immediate confidence in handling critical components. A glass door provides a clear view inside the system, and this enables operators to position parts on the manipulation stage easily. Integrated high-definition cameras add more perspectives and monitoring options to optimize every scan.

Equally at home on the smart factory floor as they are in a research laboratory, the VOXLS 30 Series offers robotic integration and the Nikon Automation OPC UA Interface, which enables closed-loop quality control to allow manufacturing to be adapted in real-time.

With configurations designed to meet diverse energy and resolution requirements, the VOXLS 30 Series helps manufacturers work towards smarter, faster, zero-defect production and R&D discovery.

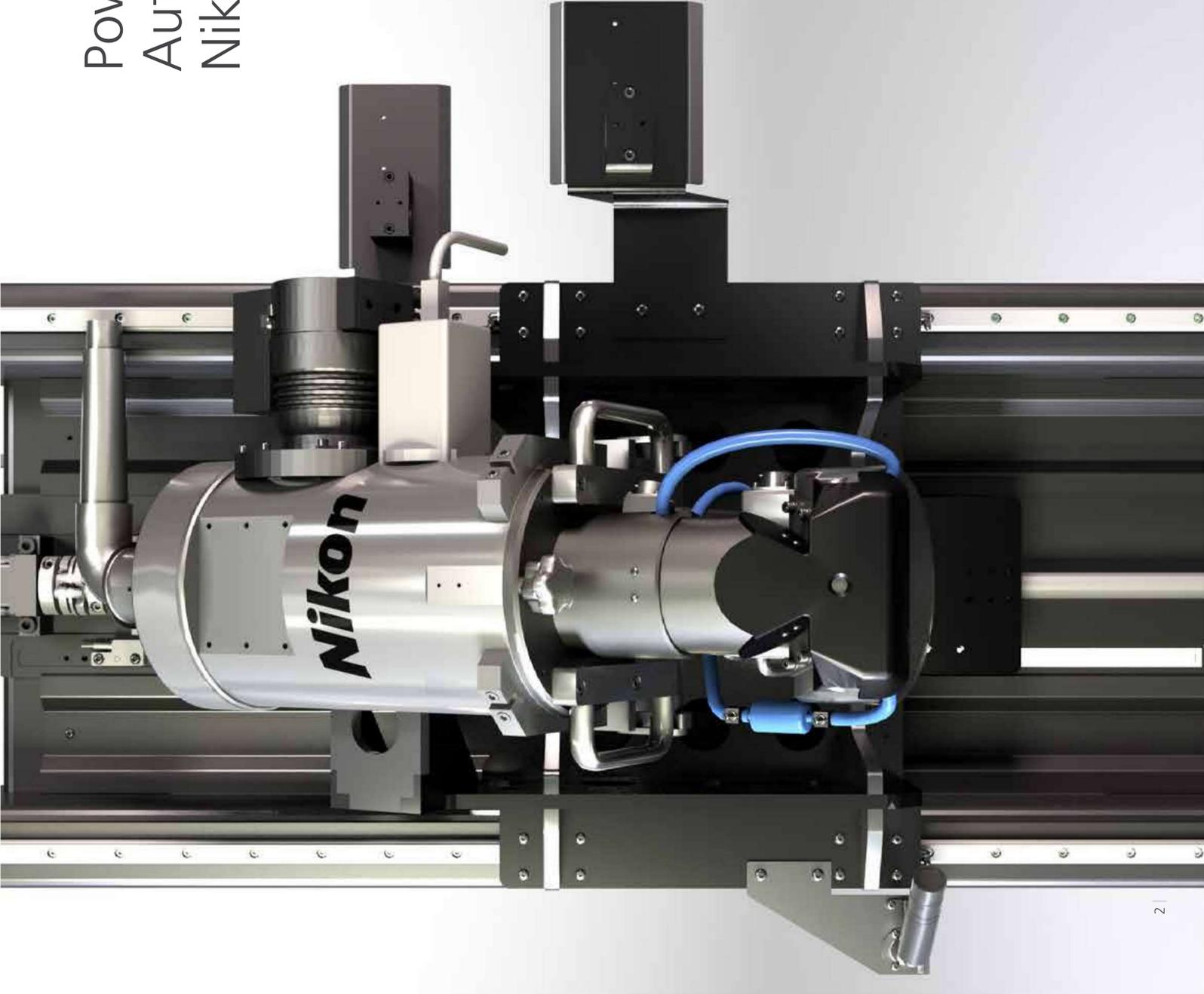

# High-speed automated inspection with exceptional visibility

## AUTOMATION-READY

The VOXLS 30 Series systems are just as at home on the factory floor as in the research lab. The motorized radiation safety doors have been engineered to open or close within just five seconds. When integrated with a robotic loader and the Nikon Automation OPC UA Interface, these systems are automation-ready for closed-loop inspection at high speed in a Quality 4.0 production line environment.

## EXCEPTIONAL VISIBILITY

All VOXLS 30 Series systems come with a 1.3-meter tall glass outer door with manipulator interlock, which gives the operator unrivalled visibility into the enclosure for precise and confident positioning of the scan object. This removes the need for light curtains and minimizes the risk of sample collision with the X-ray sources and detectors. Two internal video cameras continue to provide an excellent view even with the inner radiation safety doors shut and X-rays on.

## ERGONOMIC DESIGN

As standard, each VOXLS 30 Series system comes with a 1.5 m ergo desk with motorized height adjustment, enabling optimal positioning for all operators, ensuring they can work comfortably whether seated or standing. In addition, the integrated cabinet touch screen allows effortless operation of the radiation safety doors and quick access to system status information.

## SINGLE-PIECE CABINET

Easy to install and relocate

## LARGE ERGO DESK

Comfort for all operators

## LARGE SAMPLE CAPACITY

Accommodates samples up to 1,000 mm (Ø) x 1,300 mm (H)

## FROSTED GLASS WARNING LIGHTS

'Floating' text with increased legibility for safety

## GLASS OUTER DOOR

Full system interior visibility

## INTEGRATED TOUCH SCREEN

Door control and system status at your fingertips

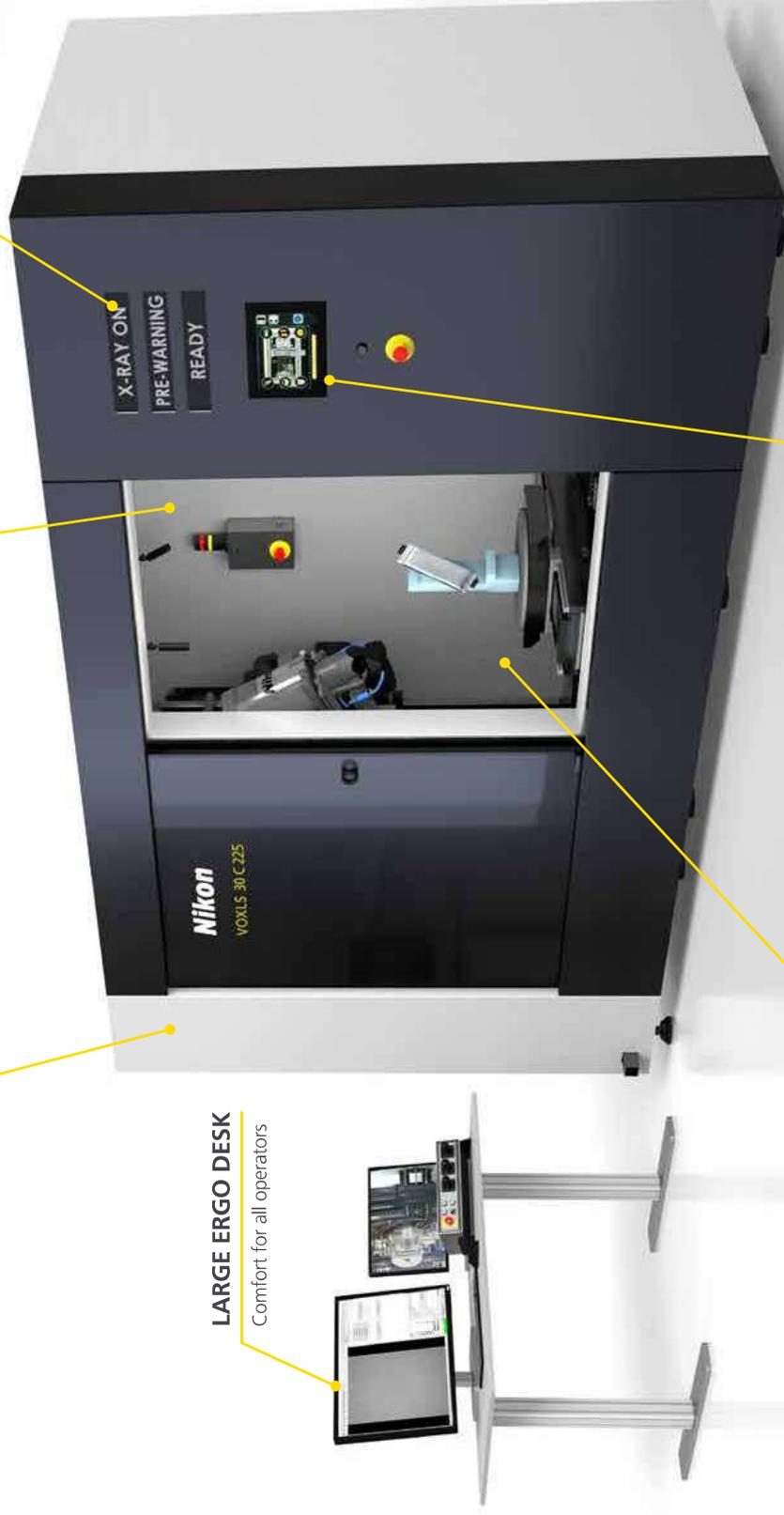

# Granite-based manipulator provides superior mechanical stability

## METROLOGY-GRADE MANIPULATOR

At the core of VOXLS 30 Series systems is a metrology-grade, granite-based manipulator coupled with rigid steel towers, high-precision motors and linear encoders. The resulting construction provides superior mechanical and thermal stability, resulting in more accurate manipulator positioning and, therefore, the generation of highly precise, repeatable measurement data throughout the entire scan volume.

## LARGE SCANNING VOLUME

The VOXLS 30 Series cabinets can accommodate items up to 1,000 mm in diameter by 1,300 mm tall. Thanks to synchronous vertical travel of the X-ray source and detector, combined with a 2-position horizontal panel shift, these systems provide impressive maximum scanning volumes of more than 600 mm diameter by more than 1,000 mm high. The VOXLS 30 C 225 model boasts an industry-leading scan volume within its size class at 620 mm diameter by 1,025 mm tall.

## MOTORIZED MOVEABLE FID

In traditional X-ray CT systems, the Focus to Imager Distance (FID) is either fixed or manually adjustable. However, the VOXLS 30 Series have motorized moveable FID, allowing the operator to effortlessly change the distance between the X-ray source and detector with sub-millimetre precision. Reducing the FID provides dramatically greater X-ray photon flux, significantly faster scan times and increased signal-to-noise ratio for enhanced image quality.

## MICROFOCUS X-RAY SOURCE

Choice of 225, 320 or 450 kV with multiple targets available

## PANEL SHIFT

Horizontal stitching for XL samples

## FLAT PANEL DETECTOR

Wide range of high resolution, high speed FPDs available

## MOTORIZED FID

Increased flux and reduced scan times

## STEEL TOWERS

Enhanced rigidity and stability

## LARGE SCANNING VOLUME

Max scan volume of 620 mm (Ø) x 1025 mm (H)

## ENHANCED PRECISION

New drive motors and encoders

## GRANITE BASE

Superior accuracy and repeatability

# Microfocus X-ray sources enable high-resolution and rapid scanning



Nikon Metrology X-ray sources are at the heart of our technology and have been designed and manufactured in-house at our UK factory since 1987. All our sources are of microfocus open-tube design, which provides micron-level resolution, exceptional image quality, and a low cost of ownership.



## 180 kV TRANSMISSION TARGET

- Our highest resolution source, enabling sub-micron feature recognition
- Liquid cooled to provide up to 180 kV energy and 20 W continuous power
- Perfect for high-resolution CT of small objects

Typical applications include biological tissues, low-density composites and foams, electronic connectors and PCBs.



## 225 kV REFLECTION TARGET

- Spot size down to 3 µm for ultra-high-resolution applications
- Liquid cooled to provide up to 225 kV energy and 225 W continuous power
- Ideal for high-resolution CT across a broad sample range

Typical applications include light metal castings, plastic ALM components, drug delivery devices and pharmaceuticals.



## 225 kV MULTI-METAL REFLECTION TARGET

- Unique to the market, with four target metals to choose from (W, Cu, Al and Mo)
- Effortless target metal changeover without the need to break vacuum
- Optimize the X-ray spectra required for challenging low kV scanning

Typical applications include low-density polymers, thin plastic films, low-contrast materials research and small natural specimens.



## 225 kV ROTATING TARGET 2.0

The second generation of Nikon's unique 225 kV rotating reflection target provides double the service interval of its predecessor. Spinning the target at high speed combined with advanced liquid cooling enables continuous operation even at 450 W full power, three times greater power density than conventional reflection targets, and significantly higher X-ray photon flux. All these factors add up to dramatically faster scan times and better signal-to-noise ratio without loss of resolution.

Typical applications include LIB pouch, cylindrical and prismatic cells, light metal ALM components and aerospace wax turbine blades.



## 450 kV ROTATING TARGET

Nikon's unique 450 kV rotating reflection target builds on the world's first 450 kV microfocus X-ray source, also designed by Nikon. Unlike traditional minifocus sources, the target's innovative cooling system provides continuous operation across the full power range up to 450 W and 5-10x higher resolution. Additional benefits include 3x greater power density and flux than Nikon's standard 450 kV source to radically accelerate acquisition while providing superior image quality.

Typical applications include LIB modules and packs, large or dense ALM components and aerospace Inconel turbine blades.



## 320 kV REFLECTION TARGET

- Higher penetrative power whilst maintaining high resolution
- Liquid cooled to provide up to 320 kV energy and 320 W continuous power
- Rapidly interchangeable with all our 225 kV targets and 180 kV transmission

Typical applications include small-to-medium-sized metal castings, medium-density automotive components and rock cores.



## 450 kV REFLECTION TARGET

- High energy microfocus source combined with a low cost of ownership
- Liquid cooled to provide up to 450 kV energy and 450 W power
- Critical for high-resolution CT of higher-density components

Typical applications include medium-to-large-sized metal castings, high-density automotive parts and rocket engine components.

# Advanced scanning technologies improve resolution, scan volume, and speed



## X-Tend Helical CT

Tall objects can be scanned in a single acquisition process, eliminating artefacts introduced by the cone beam and multi-scan stitching. This also provides the benefit of scanning objects at higher magnification, resulting in significantly higher resolution.

► Petrol-Powered Chainsaw [scanned with X-Tend Helical CT]



## Panel Shift

Thanks to horizontal detector movement, objects much wider than the field of view can be imaged and reconstructed as an automatically combined single CT volume. Additionally, small-to-medium-sized objects can be magnified over a wider area, resulting in increased resolution.

► 580 mm wide R-15 Car Tyre [scanned with Panel Shift]



## Half-Turn CT

This is designed for high throughput environments where fast cycle times are most important. This productivity gain is achieved by acquiring and reconstructing approximately half the data of conventional circular CT without loss of resolution or image quality.

► Lithium-Ion Battery Pouch Cell [scanned with Half-Turn CT]



## Pixel Split CT

Applications that require much greater resolution than typically possible benefit from a quadrupling of the pixel count. This is achieved by horizontal and vertical detector movement at the sub-pixel scale and the acquisition, combination and reconstruction of four automated circular CT scans.

► Female UK Dung Beetle (*Geotrupes spingeri*) [scanned with Pixel Split CT]

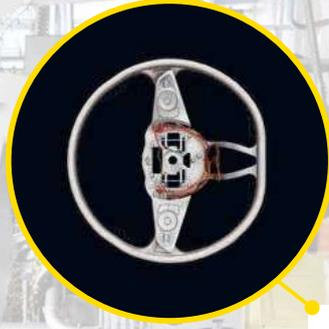

## Offset-CT

Objects wider than the detector itself can be captured in a single scan. This also allows smaller wide objects to be scanned at considerably higher magnification, providing enhanced detail.

► Heated Car Steering Wheel [scanned with Offset-CT]

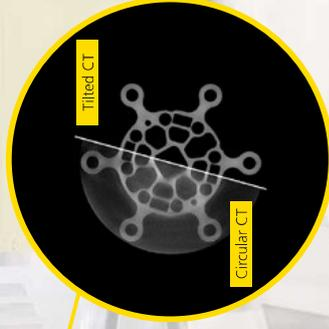

## Tilted CT

Maximizes the geometric magnification and, therefore, the resolution of planar or high aspect ratio objects with a small region of interest. This is made possible by tilting the component's axis of rotation, which also yields superior image quality in areas previously masked by more dense material.

► Cylindrical Aluminium Extrusion [scanned with Tilted CT]

# Enabling automated inspection, calibration, and evaluation

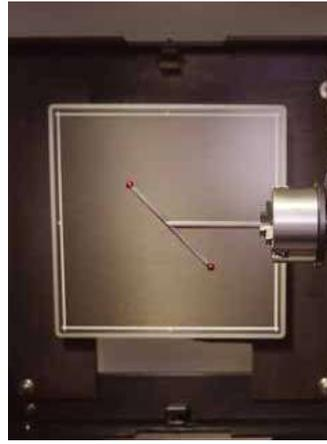

## LiB.Overhang Analysis

Automatic high-speed analysis of anode overhang in Lithium-ion batteries. Cutting-edge Deep Learning AI precisely and reliably analyses the fastest CT scans, exporting repeatable results in a machine-readable format. LiB.Overhang Analysis enables closed-loop process control, resulting in improved product quality and significantly reduced scrap.

## Local Calibration

Allows fast, automated calibration of voxel size at any CT scan position, rather than the user having to perform the function manually. This leads to a radical improvement in measurement accuracy for metrology applications. As the CT scan position is calibrated with reference to a known artefact, measurements can be made with high confidence.

## Dual.Material CT

An innovative reconstruction technique for high throughput production environments that reduces streak and beam hardening artefacts caused by metal and other dense parts in dual-material samples. Discrimination between materials is greatly improved, resulting in clearer visualisation and facilitating automatic inspection. Dual.Material CT eliminates the need for long scan times and manual postprocessing routines.

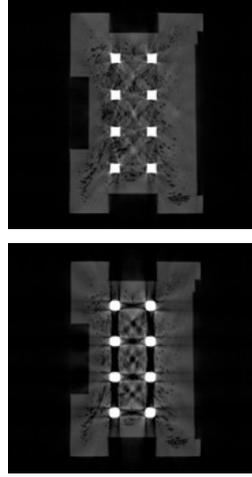

Traditional reconstruction

With Dual.Material CT



## ASTM E2737 Detector Evaluation Kit

The condition of flat panel detectors has a considerable influence on the efficiency and accuracy with which features are detected and measured, so evaluating and tracking their performance over time is crucial. Nikon's unique hardware and software evaluation kit enables detailed trend analysis and performance tracking in accordance with ASTM E2737 and produces clear graphical visualisation of results, all within a fully automated process.

# Rapid inspections in pursuit of zero-defect parts

## BATCH CT

As standard, Nikon Metrology's Inspect-X control software allows operators to save scan profiles to be recalled later. These profiles define all acquisition, reconstruction and analysis parameters, ensuring repeatability of the complete inspection process. The easy-to-use interface eliminates the requirement for advanced programming skills and manual parameter selection, freeing up the operator to carry out other tasks.



## ROBOTIC LOADING

In-line CT enables fully autonomous inspection in production environments where critical complex parts require rapid process control. By integrating CT systems with robotics and conveyors, parts can be loaded and scanned automatically for rapid detection of variations. This inspection data is fed back in real-time to optimize processes, enabling tightly controlled and continuously improved production quality. With robotic automation and real-time feedback, in-line CT solutions allow production to run lights-out with rapid adaptation for zero defects.



## AUTOLOADER

With Nikon's Autoloader, placing a rack containing a series of sample holders into the system is the only manual operation needed. Part loading and identification, program selection, data acquisition, analysis and reporting are entirely automated.



## NIKON AUTOMATION OPC UA INTERFACE

Nikon CT systems now feature an industry-standard OPC UA interface, enabling easier integration with automation equipment than the previous proprietary IPC interface. With OPC UA, integrators can rapidly connect Nikon CT data to optimize production per the Quality 4.0 goal of zero defects via real-time process control. This simplifies installing Nikon systems in smart factories, saving time and costs. The open OPC UA protocol provides a common language for secure communication between machines, aligning with the Industry 4.0 trend of production networking for maximum efficiency, quality, and flexibility.

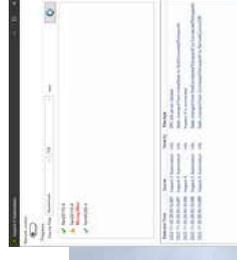



# Quality 4.0 CT inspection drives zero-defect production in smart factories

The goal of Industry 4.0 is greater manufacturing competitiveness through lower costs, faster adaptation, and shortened time-to-market. This requires a shift in quality control from simply qualifying good or bad products to proactively controlling processes for zero defects via real-time data.

Called Quality 4.0, this new paradigm demands frequent, detailed inspection as close to real-time as possible. With automated analysis of internal and external part features in a single fast process, computed tomography is ideally suited to provide the rapid feedback essential for Quality 4.0 and optimizing smart factory production.

## 100% PART INSPECTION

The in-line CT inspection system enables fully automated quality control for critical complex parts in Industry 4.0 production environments. Robots identify, load, and position parts for scanning according to database recipes, while conveyors transport them just in time.

Automated doors and acquisition eliminate user input, allowing complete CT analysis and sentencing in under a minute. Parallel scanning and analysis can further optimize the process for long Takt times.

With tight integration to handle each step from loading to results, in-line CT provides the rapid feedback essential for zero-defect manufacturing of sophisticated components.

## AUTOMATION BENEFITS



Increase productivity



Reduce costs



Improve quality



Closed-loop manufacturing



Centralized data



Deskill complex tasks



# Nikon VOXLS 30 C 225

Largest 225 kV scan volume in its class



The VOXLS 30 C 225 is a feature-packed, premium X-ray CT system designed for small-to-medium-sized samples of low to medium-density materials.

The system suits demanding environments requiring high scan throughput, especially when configured with Nikon's 225 kV Rotating Target 2.0 source.

Optional Auto.Filament Control can double the filament lifetime, decreasing system downtime for maintenance and increasing productivity.

Pair the system with one of Nikon's Automation solutions, and you have an ultimate quality control tool for reliable inspection on the production floor.



## VOXLS 30 C 225 HIGHLIGHTS

- ✓ Max Part Size:  
1,000 mm (Ø) x 1,300 mm (H)
- ✓ Max Scan Volume:  
620 mm (Ø) x 1,025 mm (H)
- ✓ Max Sample Mass:  
50 kg central load
- ✓ Auto.Filament Control available

## 225 kV applications



**Aerospace**  
Wax turbine blades



**Electric Vehicles**  
Lithium-ion battery pouch, cylindrical and prismatic cells



**Small Castings**  
Light metals  
(magnesium and aluminium)



**Additive Layer Manufacturing**  
Small-to-medium plastic, low-density metal components

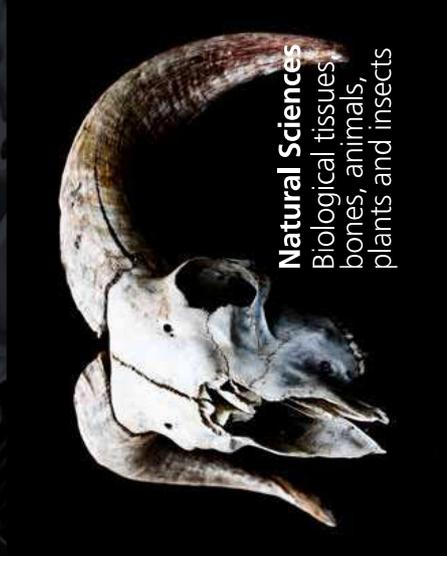

**Natural Sciences**  
Biological tissues, bones, animals, plants and insects



**Medical Devices and Pharmaceuticals**  
Inhalers, injectors, tablets, powder sachets

# Nikon VOXLS 30 C 320

One X-ray source, limitless applications



The VOXLS 30 C 320 is available with up to five target modules within a single source configuration for those demanding the most versatility possible in a single-tube X-ray system.

These empower researchers and engineers to advance their non-destructive testing capabilities and help make new discoveries, validate designs, and accelerate innovation.

#### AVAILABLE TARGET MODULES

- 180 kV Transmission: Ultra-high resolution with sub-micron feature recognition
- 225 kV Reflection: Outstanding imaging quality and resolution across a broad sample range
- 225 kV Rotating Target 2.0: 3x higher power density over the Reflection target for significantly faster scan times
- 320 kV Reflection: Increased power for dense samples at high resolution
- 225 kV Multi-Metal Reflection Target: Unrivaled flexibility for complex applications



#### VOXLS 30 C 320 HIGHLIGHTS

- ✓ Max Part Size: 1,000 mm (Ø) x 1,300 mm (H)
- ✓ Max Scan Volume: 610 mm (Ø) x 1,050 mm (H)
- ✓ Max Sample Mass: 100 kg central load
- ✓ Penta Source available

## 320 kV applications



**Aerospace**  
Wax and titanium turbine blades



**Electric Vehicles**  
Lithium-ion battery cells and modules



**Small-to-Mid-Sized Castings**  
Magnesium, aluminium and titanium

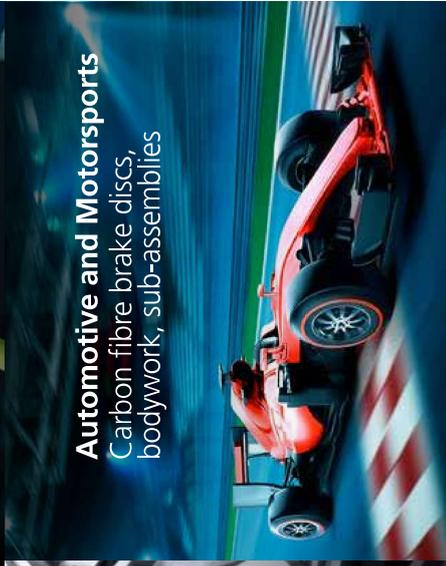

**Automotive and Motorsports**  
Carbon fibre brake discs, bodywork, sub-assemblies



**Additive Layer Manufacturing**  
Medium-sized plastic or low-density metal components



**Materials Research**  
Composites and midrange-density metals

# Nikon VOXLS 30 C 450

Unmatched resolution on high-density samples



The VOXLS 30 C 450 is a uniquely positioned system, ideal for inspecting small-to-mid-sized, higher-density components in a space-efficient footprint. The single source, dual detector-capable system offers a full range of Nikon's scan enhancement acquisition modes, traditionally only found on larger systems.

The VOXLS 30 C 450 can be teamed with Nikon's in-house CLDA (Curved Linear Diode Array), a high-sensitivity linear detector specifically designed for Nikon's 450 kV microfocus source that is perfect for 2D CT and scatter correction.



## VOXLS 30 C 450 HIGHLIGHTS

- ✓ Max Part Size: 1,000 mm (Ø) x 1,300 mm (H)
- ✓ Max Scan Volume: 610 mm (Ø) x 1,050 mm (H)
- ✓ Max Sample Mass: 100 kg central load
- ✓ Dual Detector Flexibility available

## 450 kV applications



**Aerospace**  
Turbine blades and nozzle guide vanes

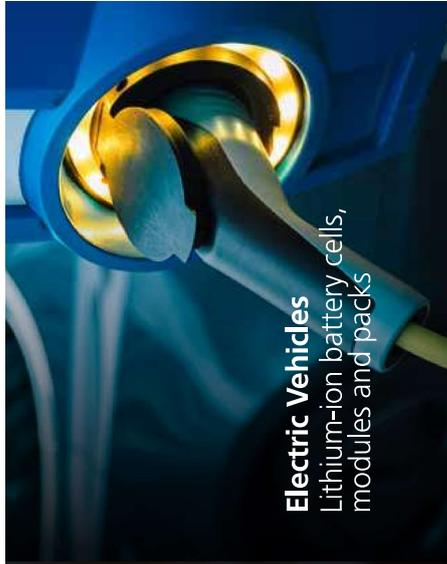

**Electric Vehicles**  
Lithium-ion battery cells, modules and packs

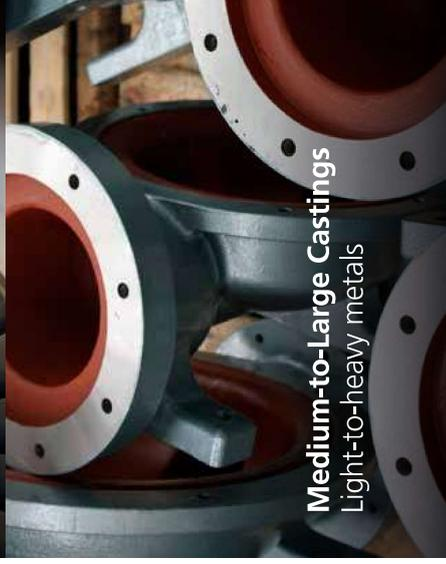

**Medium-to-Large Castings**  
Light-to-heavy metals



**Space and Defense**  
Rocket engine components, sub and full assemblies

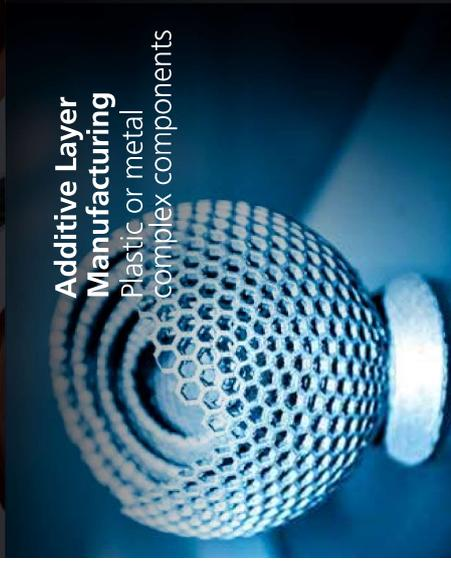

**Additive Layer Manufacturing**  
Plastic or metal complex components



**Materials Research**  
Composites and light-to-heavy metals/alloys

# Nikon's Versatile Large-Volume X-ray CT System Option: VOXLS 40 Series

The new VOXLS 30 Series supplies a solution for those who need to inspect small-to-mid-sized samples of low-to-high density. But what about those companies and organizations searching for more?

Meet the VOXLS 40 Series, Nikon's versatile, large-envelope X-ray and CT systems, which offer a multitude of configuration options to manage the most exacting inspection requirements.

Larger than the VOXLS 30 Series, the VOXLS 40 Series can perform virtually limitless tasks within industry, inspection bureaux and academia thanks to its ability to inspect larger, denser items, internally and externally.

The VOXLS 40 Series can inspect objects in phenomenal detail in an expansive scanning envelope able to accommodate samples up to 1,275 mm swept diameter and 1,800 mm tall.

And just like the VOXLS 30 Series, the VOXLS 40 Series can be combined with an integrated robotic loader and the Nikon Automation OPC UA Interface to make it automation-ready for closed-loop, high-speed inspection in a Quality 4.0 production line environment.

Discover more about the VOXLS 40 Series today and learn how it can help deliver industry-leading large-volume inspection for any enterprise environment.

Learn more about  
the VOXLS 40 C 450:



# Nikon VOXLS 40 C 450

Maximum capacity in a single-piece cabinet

## FLEXIBILITY AND FUNCTIONALITY

The VOXLS 40 C 450 comes equipped with two Nikon high-power, microfocus X-ray sources (225 kV and 450 kV), providing exceptional flexibility for scanning various component sizes and material densities.

Both sources are equipped with Nikon's unique rotating target technology, providing ultra-high resolution at industry-leading power to enable even the most minor defects inside an object to be identified quickly and easily.

The system also possesses dual detector functionality, with a choice of industry-leading, flat panel detectors (FPD) providing ultra-clear images for 3D Computed Tomography (CT) or 2D digital radiography, as well as Nikon's unique Curved Linear Diode Array (CLDA) for 2D CT and scatter correction of high-density materials.

## GLASS BI-PARTING OUTER DOORS

Full system interior visibility

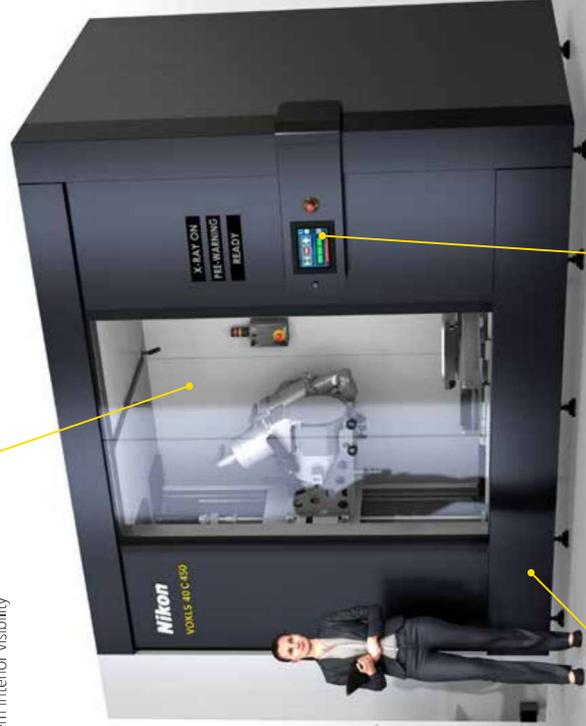

## INTEGRATED CABINET TOUCH SCREEN

Doors and X-ray source control at your fingertips

## LARGE ERGO DESK

Comfort for all operators



## SINGLE-PIECE CABINET

Easy to install and relocate

## DUAL SOURCE

225 and 450 kV microfocus

## DUAL DETECTOR

Available with FPD and CLDA

## STEEL TOWERS

Enhanced Rigidity and Stability

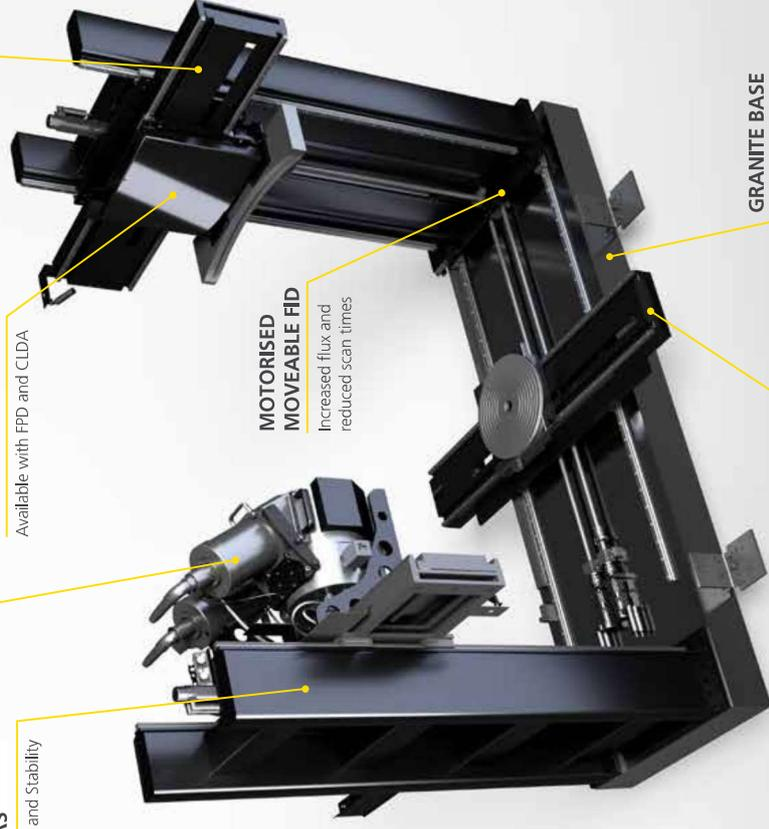

## MOTORISED MOVEABLE FID

Increased flux and reduced scan times

## ENHANCED PRECISION

New drive motors and encoders

## GRANITE BASE

Superior Accuracy and Repeatability

## LARGE SCANNING VOLUME

Thanks to the synchronous vertical travel of the sources and detectors, combined with three-position horizontal panel shift, the VOXLS 40 C 450 boasts the largest scanning envelope of any single-piece cabinet system on the market today.

Objects up to 800 mm in diameter, 1,415 mm in height and 275 kg in weight can be inspected in exceptional detail.

Learn more about the VOXLS 40 C 450:



# Specifications

Sources					
Nikon Microfocus X-ray Sources	Max. kV	Max. power	Focal spot size range		System
180 kV Transmission Target	180 kV	20 W	1 µm up to 3 W	20 µm at 20 W	VOXLS 30 C 225 and VOXLS 30 C 320
225 kV Reflection Target	225 kV	225 W	3 µm up to 7 W	225 µm at 225 W	VOXLS 30 C 225 and VOXLS 30 C 320
225 kV Multi-Metal Target	225 kV	225 W	3 µm up to 7 W	225 µm at 225 W	VOXLS 30 C 225 and VOXLS 30 C 320
225 kV Rotating Target 2.0	225 kV	450 W	10 µm up to 30 W	160 µm at 450 W	VOXLS 30 C 225 and VOXLS 30 C 320
320 kV Reflection Target Module	320 kV	320 W	30 µm up to 30 W	320 µm at 320 W	VOXLS 30 C 320
450 kV Reflection Target	450 kV	450 W	80 µm up to 50 W	320 µm at 450 W	VOXLS 30 C 450
450 kV Rotating Reflection Target	450 kV	450 W	80 µm up to 100 W	113 µm at 450 W	VOXLS 30 C 450

Detectors					
16-bit Detectors	Field of View	Pixel Size	Max. frame rate		System
			at 1×1 binning	at 2×2 binning	
Varex XRD 1611	400 × 400 mm	100 µm	3.75 fps	7.5 fps	VOXLS 30 C 225, VOXLS 30 C 320 and VOXLS 30 C 450
Varex XRD 1620	400 × 400 mm	200 µm	3.75 fps	7.5 fps	VOXLS 30 C 225, VOXLS 30 C 320 and VOXLS 30 C 450
Varex XRD 1621 EHS	400 × 400 mm	200 µm	15 fps	30 fps	VOXLS 30 C 225, VOXLS 30 C 320 and VOXLS 30 C 450
Varex XRD 4343CT	430 × 430 mm	150 µm	15 fps	30 fps	VOXLS 30 C 225
Varex XRD 4343N	430 × 430 mm	150 µm	15 fps	30 fps	VOXLS 30 C 320 and VOXLS 30 C 450
Nikon Metrology CLDA	0.4 × 850 mm	415 µm	50 fps		VOXLS 30 C 450

	VOXLS 30 C 225	VOXLS 30 C 320	VOXLS 30 C 450
Manipulator			
# Axes	7	7	7
Max. Sample Envelope	620 (Ø) × 1,025 (H) mm	610 (Ø) × 1,050 (H) mm	FPD: 610 (Ø) × 1,050 (H) mm CLDA: 570 (Ø) × 640 (H) mm
Max. FID (nominal)	1,382 mm	1,261 mm	FPD: 1,261 mm CLDA: 1,200 mm
FID Type	Motorized		FPD: Motorised CLDA: Fixed
Max. Sample Mass	50 kg	100 kg	100 kg

	VOXLS 30 C 225	VOXLS 30 C 320	VOXLS 30 C 450
Cabinet			
Length	3,217 mm		
Width	1,477 mm		
Height	2,018 mm		
Max. Mass	6,950 kg	10,350 kg	10,350 kg

Note: All figures are intended for summary purposes and may vary based on exact system configuration. Contact your Nikon representative for detailed specifications of each configuration.



**NIKON CORPORATION**  
Shinagawa Intercity Tower C, 2-15-3, Konan,  
Minato-ku, Tokyo 108-6290 Japan  
Tel: +81 3 6433 3701  
<https://industry.nikon.com>

ISO 14001 Certified  
for NIKON CORPORATION

ISO 9001 Certified  
for NIKON CORPORATION  
Industrial Metrology Business Unit

**NIKON METROLOGY EUROPE NV**  
Interleuvenlaan 86  
B-3001 Leuven, Belgium  
Tel: +32 16 74 01 00  
Sales.Europe.NM@nikon.com

**NIKON METROLOGY SARL**  
UNITED KINGDOM Tel: +44 1332 811 349  
Sales.UK.NM@nikon.com

**NIKON METROLOGY SARL**  
FRANCE Tel: +33 1 60 86 09 76  
Sales.France.NM@nikon.com

**NIKON METROLOGY GMBH**  
GERMANY Tel: +49 211 45 44 69 51  
Sales.Germany.NM@nikon.com

**NIKON METROLOGY, INC.**  
12701 Grand River Road, Brighton,  
MI 48116 U.S.A.  
Tel: +1 810 220 4360  
Sales.NM-US@nikon.com

**NIKON METROLOGY - MÉXICO**  
Sales.NM-MX@nikon.com

**NIKON PRECISION (SHANGHAI) CO., LTD.**  
CHINA Tel: +86 21 6841 2050 (Shanghai branch)  
CHINA Tel: +86 10 5831 2028 (Beijing branch)  
CHINA Tel: +86 20 3882 0551 (Guangzhou branch)  
Web.Nis@nikon.com

**NIKON INSTRUMENTS KOREA CO. LTD.**  
KOREA Tel: +82 2 6288 1900

**NIKON SINGAPORE PTE. LTD.**  
SINGAPORE Tel: +65 6559 3651  
NSG.Industrial-sales@nikon.com

**PT. NIKON INDONESIA**  
INDONESIA Tel: +62 267 864 3949  
PTN.Instruments@nikon.com

**NIKON SALES (THAILAND) CO., LTD.**  
THAILAND Tel: +66 2633 5100

More offices and resellers at <https://industry.nikon.com>